

MSS Reference Manual

For the Lantronix MSS Family of Device Servers

The information in this guide may change without notice. The manufacturer assumes no responsibility for any errors which may appear in this guide.

UNIX is a registered trademark of The Open Group. Ethernet is a trademark of XEROX Corporation. NetWare is a trademark of Novell Corp. Windows is a trademark of Microsoft.

Copyright 2001, Lantronix. All rights reserved. No part of the contents of this book may be transmitted or reproduced in any form or by any means without the written permission of Lantronix. Printed in the United States of America.

The revision date for this manual is **4 June, 2001**.

Part Number: 900-157

Rev. D

WARNING

This equipment has been tested and found to comply with the limits for a Class A digital device pursuant to Part 15 of FCC Rules. These limits are designed to provide reasonable protection against such interference when operating in a commercial environment. This equipment generates, uses, and can radiate radio frequency energy, and if not installed and used in accordance with this guide, may cause harmful interference to radio communications.

Operation of this equipment in a residential area is likely to cause interference in which case the user, at his or her own expense, will be required to take whatever measures may be required to correct the interference.

Changes or modifications to this device not explicitly approved by Lantronix will void the user's authority to operate this device.

Contents

1: Introduction.....	1-1
1.1 What's New	1-1
1.2 Command Syntax.....	1-1
1.3 Command Line Editing.....	1-2
1.4 Help.....	1-3
1.5 About This Manual	1-3
2: Command Reference.....	2-1
2.1 Backward	2-2
2.2 Change 80211	2-2
2.2.1 Change 80211 Enabled	2-2
2.2.2 Change 80211 Antenna.....	2-3
2.2.3 Change 80211 Channel.....	2-4
2.2.4 Change 80211 ESSID	2-4
2.2.5 Change 80211 Fragmentation.....	2-5
2.2.6 Change 80211 MAC Address.....	2-5
2.2.7 Change 80211 Network Mode.....	2-6
2.2.8 Change 80211 Power	2-7
2.2.9 Change 80211 Region.....	2-7
2.2.10 Change 80211 Reset	2-8
2.2.11 Change 80211 RTS	2-8
2.2.12 Change 80211 WEP.....	2-9
2.3 Change Access	2-10
2.4 Change Autobaud.....	2-11
2.5 Change Autostart	2-12
2.6 Change Backward Switch.....	2-14
2.7 Change Bootgateway	2-14
2.8 Change BOOTP	2-15
2.9 Change Break.....	2-15
2.10 Change Buffering.....	2-16
2.11 Change Charsize	2-16
2.12 Change Datasend	2-17
2.13 Change Dedicated	2-19
2.14 Change DHCP.....	2-21
2.15 Change Domain	2-21
2.16 Change DSRLLogout	2-22
2.17 Change DTRWait.....	2-22
2.18 Change Flow Control.....	2-23
2.19 Change Forward Switch.....	2-24
2.20 Change Gateway	2-24
2.21 Change Inactive Logout.....	2-25
2.22 Change Inactive Timer.....	2-25
2.23 Change Incoming	2-26
2.24 Change IPAddress.....	2-27

2.25 Change IPSecurity	2-27
2.26 Change LAT CircTimer	2-28
2.27 Change LAT Groups.....	2-29
2.28 Change LAT Identification	2-29
2.29 Change Loadhost	2-29
2.30 Change Local Switch	2-30
2.31 Change Loginpass	2-31
2.32 Change Modem Control.....	2-31
2.33 Change Modem Emulation	2-32
2.34 Change Name.....	2-32
2.35 Change Nameserver	2-33
2.36 Change NetWare Encapsulation	2-33
2.37 Change NetWare Internal Network	2-34
2.38 Change NetWare Loadhost	2-34
2.39 Change NetWare Routing	2-35
2.40 Change Parity.....	2-35
2.41 Change Passflow	2-36
2.42 Change Password Incoming.....	2-37
2.43 Change Password Limit	2-37
2.44 Change Password Protect.....	2-38
2.45 Change Portname	2-38
2.46 Change Preferred	2-39
2.47 Change Privpass.....	2-40
2.48 Change RARP	2-40
2.49 Change Retransmit Limit.....	2-41
2.50 Change Rlogin	2-41
2.51 Change RS485	2-42
2.52 Change Secondary	2-43
2.53 Change Session Limit	2-43
2.54 Change Signal Check.....	2-43
2.55 Change Silentboot.....	2-44
2.56 Change SNMPSetComm	2-44
2.57 Change Software.....	2-45
2.58 Change Speed.....	2-45
2.59 Change Startup.....	2-46
2.60 Change Stopbits	2-47
2.61 Change Subnet Mask	2-47
2.62 Change TCPKeepalive.....	2-48
2.63 Change Telnetdest.....	2-48
2.64 Change Telnetpad	2-49
2.65 Change Termttype.....	2-49
2.66 Change Timeserver	2-50
2.67 Change Verify	2-51
2.68 Change WINS	2-51
2.69 Crypt Password.....	2-52
2.70 Disk.....	2-53
2.71 Delete IPSecurity	2-57
2.72 Disconnect.....	2-57
2.73 Finger	2-57
2.74 Forward.....	2-58

2.75 Help.....	2-58
2.76 Hostlist.....	2-58
2.77 Initialize.....	2-59
2.78 LAT.....	2-60
2.79 Logout Port.....	2-60
2.80 Netstat.....	2-61
2.81 Ping.....	2-61
2.82 Resume.....	2-61
2.83 Rlogin.....	2-62
2.84 RTC.....	2-62
2.85 Set Privileged.....	2-63
2.86 Show 80211.....	2-63
2.87 Show Hostlist.....	2-64
2.88 Show IPsecurity.....	2-64
2.89 Show NetWare.....	2-64
2.90 Show Nodes.....	2-64
2.91 Show Ports.....	2-65
2.92 Show RS485.....	2-65
2.93 Show Server.....	2-65
2.94 Show Services.....	2-66
2.95 Show Session.....	2-66
2.96 Show SNMP.....	2-67
2.97 Show Users.....	2-67
2.98 Show Version.....	2-67
2.99 Source.....	2-67
2.100 SPX.....	2-68
2.101 Telnet.....	2-68
2.102 Test.....	2-69
2.103 Zero.....	2-69

A: Contact Information.....A-1

A.1 Problem Report Procedure.....	A-1
-----------------------------------	-----

B: Environment Strings.....B-1

B.1 Usage.....	B-1
B.1.1 Multiple Strings.....	B-1
B.2 Available Strings.....	B-1
B.2.1 Usage Examples.....	B-2
2.2.1.1 nnnn.....	B-2
2.2.1.2 +C and -C.....	B-2
2.2.1.3 +D and -D.....	B-2
2.2.1.4 +E and -E.....	B-2
2.2.1.5 OR.....	B-3
2.2.1.6 OS.....	B-3
2.2.1.7 +P and -P.....	B-3
2.2.1.8 R.....	B-3
2.2.1.9 T.....	B-3
2.2.1.10 U.....	B-3
2.2.1.11 Y.....	B-4
2.2.1.12 LD=port#.....	B-4

2.2.1.13 LN=node# B-4

C: Show 802.11 Errors.....C-1

C.1 Introduction C-1

C.2 Error Bits C-1

C.2.1 Leftmost Number C-1

C.2.2 Rightmost Number C-3

Index

1: Introduction

The Lantronix MSS family of Device Servers allows you to network-enable a variety of serial devices that were not originally designed to be networked: personal computers, terminals, modems, industrial machinery, and more. Certain MSS models offer fiber optic Ethernet, PC card support for 802.11, modem, and ATA Flash cards, and multiple serial ports, ensuring a product for almost any networking need.

This manual provides the complete command set for all products in the MSS family. These commands can be entered at the command line to configure the MSS to best meet your needs. While most basic MSS features can be configured using EZWebCon or ThinWeb Manager, the command line interface allows you to customize some of the more advanced features.

This chapter provides a brief introduction to the command line environment for the MSS.

- ◆ *What's New* on page 1-1 describes what's changed since the last revision of this manual.
- ◆ *Command Syntax* on page 1-1 provides the conventions used in the command diagrams and descriptions.
- ◆ *Command Line Editing* on page 1-2 lists the keys that should be used for line editing.
- ◆ *Help* on page 1-3 offers information on various types of context-sensitive help.

Note: *Parts of this manual assume knowledge of the IEEE 802.11 Standard governing wireless networking. If you do not understand wireless networking concepts and implementation, please refer to the Standard or the documentation that came with your wireless networking PC Card.*

Throughout this manual, the term **MSS** refers to the MSS family in general. If a particular feature or command applies only to certain models, it will be noted as such.

1.1 What's New

- ◆ Most commands now include either a Port or Server parameter. These parameters are only necessary if you are configuring an MSS4, which is the first member of the MSS family to have multiple configurable serial ports. The Port parameter allows you to configure port-specific options; the Server parameter applies to settings that affect the entire MSS.
- ◆ The **Disk** commands provide a wide-range of disk management options for the MSS4, MSS100, MSSLiteX, and the MSS-VIA. Options for managing the internal flash disk and formatting ATA Flash cards are included under this command tree.

1.2 Command Syntax

Command line entry is both simple and powerful. Users can enter up to 132 characters on a command line, or abbreviate commands to a sequence of the smallest unique keywords (sometimes single characters). Commands are executed when the Return key is pressed or when the command line exceeds 132 characters.

Please read this section carefully so you can understand the conventions used in the command descriptions.

- ◆ Commands are listed in alphabetical order.
- ◆ Some commands do not apply to all members of the MSS family, and are so noted.
- ◆ Commands and keywords appear in **BOLD** face.
- ◆ User-entered parameters appear in *italics*. You must replace the italicized word.

When entering a parameter that is case-sensitive, such as file and host names, enclose the parameter in quotes to preserve case.

- ◆ The Port portlist and Server parameters currently only apply to commands issued for the MSS4. Read each command carefully for more details.
- ◆ When two or more parameters appear in curly braces { }, you must choose one and only one of the items within each set of braces to complete the command.
- ◆ Parameters that appear in brackets [] are optional. If more than one parameter appears in a single set of brackets, only one parameter may be chosen at a time. Single parameters enclosed in brackets may be omitted from the command, or used in combination with one another.
- ◆ The MSS has a reduced command set from the EPS, ETS, and MPS product lines. **Change** commands replace the Set/Define Server and Set/Define Port commands used in the earlier products.

A single Change command will take effect immediately (like a Set command), and will remain in effect until another Change command is issued (like a Define command). The exceptions are the Change Port and Set Privileged commands, which do not take effect until the port is logged out.

1.3 Command Line Editing

The following table lists keys that can be used for command line editing.

Table 1-1: Command Line Editing Keys

Key	Purpose
Return	Executes the current command line
Delete	Deletes the character before the cursor
Ctrl-A	Toggles insertion mode (insert or overstrike)
Ctrl-D	Logs the user out of the server
Ctrl-E	Moves the cursor to the end of the line
Ctrl-H or Backspace	Moves the cursor to the beginning of the line
Ctrl-R	Redisplays the current command
Ctrl-U	Deletes the entire line

Table 1-1: Command Line Editing Keys

Key	Purpose
Ctrl-Z	Logs the user out of the server
Left Arrow	Moves the cursor left
Right Arrow	Moves the cursor right
Ctrl-P or Up Arrow	Recalls the previous command
Ctrl-N or Down Arrow	Recalls the next command
<i>!text</i>	Recalls the last command starting with <i>text</i>
!!	Recalls and implements the last command

1.4 Help

Context-sensitive help is available at any time. You may type **Help** by itself for overall help, **Help <command>** for help on a specific command, or a partial command line followed by a question mark for help on what is appropriate at that particular point. See **Help** on page 2-58 for more details.

1.5 About This Manual

The rest of this *Reference Manual* is divided as follows:

- ◆ Chapter 2, *Command Reference*, contains a comprehensive listing of all MSS commands. These commands can be entered at the command line to configure, monitor, and use the MSS.
- ◆ Appendices provide supplementary information. Read them as necessary.
- ◆ The comprehensive *Index* can be used to find specific information.

For installation and setup information, refer to your *Installation Guide*. It is provided in printed form, and you can find HTML and PDF versions on the distribution CD-ROM and on the Lantronix web site (www.lantronix.com).

2: Command Reference

This chapter describes all commands that can be used with the MSS. The commands are listed in alphabetical order, excluding the Ports and Server parameters, which apply only to the MSS4. For example, **Change Server Bootgateway** is considered the same command as **Change Bootgateway** and is alphabetized according to the latter.

Commands that configure the MSS serial ports will not affect a dedicated console port unless explicitly stated in the individual command description.,

Some commands can be used with environment strings, which are discussed in detail in *Appendix B*.

The following items are provided in the description of each command.

- ◆ The command's full syntax, shown in diagram form. See *Command Syntax* on page 1-1 for more information on the command syntax.
- ◆ Any restrictions on the command, such as whether you must be the privileged user to use it
- ◆ Potential errors that may be encountered when using the command
- ◆ Default settings, where applicable
- ◆ Examples of the command, where applicable
- ◆ Cross-references to related commands

2.1 Backward

BACKWARD

Moves the user to the previous session when entered in Local mode.

See Also Change Backward Switch, page 2-14; Show Session, page 2-66.

2.2 Change 80211

Note: *The Change 80211 Reset command must be entered after any 802.11 configuration command is issued. The changes made by the configuration commands will not take effect until after the Reset command is used. The Change 802.11 Enabled/Disabled command requires a reboot before the change will take effect.*

2.2.1 Change 80211 Enabled

CHANGE 80211 { ENABLED } { DISABLED }
--

When 802.11 is enabled, the MSS checks for a compatible 802.11 wireless Ethernet PC card at startup and, if one is present, uses the card instead of a wired Ethernet port. If no valid PC card is detected at startup, the MSS uses the 10/100BASE-T (or, for the MSS4, the 100BASE-FX) network connection.

When 802.11 is disabled, the MSS will ignore an installed 802.11 card and will only look for a compatible wired Ethernet connection.

You must reboot the MSS before those changes will take place.

Restrictions Requires privileged user status.

Only applies to the MSS-VIA and certain MSS4 models. For the MSS4, only one 802.11 card can be installed at a time. The card can be installed in either slot of the MSS4.

Parameters

Enabled

Prompts the MSS to check for a compatible 802.11 wireless Ethernet networking PC card at startup. If one is present, wireless networking will be used instead of the wired Ethernet connection. You must reboot the MSS after entering this command.

Disabled

Prompts the MSS to only look for a compatible 10/100BASE-T (or, for the MSS4, the 100BASE-FX) wired Ethernet connection at startup. You must reboot the MSS after entering this command.

Defaults Enabled

See Also Show 80211, page 2-63

2.2.2 Change 80211 Antenna

```
CHANGE 80211 ANTENNA { RX } { list }
                   { TX } { DEFAULT }
```

Controls the antenna(s), if any, on the installed wireless card. Not all antennas can be used for both receive and transmit, so be sure to read your card documentation completely. The default settings should work in most applications.

Any configuration changes you make with the above commands will not take place until you issue the **Change 80211 Reset** command.

Restrictions Requires privileged user status.

Only applies to the MSS-VIA and certain MSS4 models.

Errors If you enter a command that is not applicable to the 802.11 card currently in use, you will receive an Error message.

Parameters **RX**
Specifies the antennas used to receive

TX
Specifies the antennas used to transmit.

list
Enter an integer or group of integers separated by commas (e.g. 1,2,3) to specify the affected antenna(s). Antennas are numbered consecutively starting with antenna number one. See the documentation that came with your card for antenna numbering information.

Default
Sets the antennas to their default transmit and receive values.

Examples

```
Local>> CHANGE 80211 ANTENNA RX DEFAULT
Local>> CHANGE 80211 RESET
```

See Also Show 80211, page 2-63

2.2.3 Change 80211 Channel

```
CHANGE 80211 CHANNEL { num
                       ANY }
```

Sets the MSS operating frequency within the 2.4 GHz band allotted to wireless networking. A direct-sequence 802.11 network on one channel will affect reception on channels up to two numbers away. For best performance on collocated wireless networks, you should select channels that are at least five channels apart from each other. For example, three networks could be put on channels 1, 6, and 11 (depending on your regulatory region).

Any configuration changes you make with the above commands will not take place until you issue the **Change 80211 Reset** command.

Restrictions	Requires privileged user status. Only applies to the MSS-VIA and certain MSS4 models.
Errors	If you enter a command that is not applicable to the 802.11 card currently in use, you will receive an Error message.
Parameters	num Enter a valid channel for your regulatory region. This number should be an integer between 1 and 14. Recommended for ad-hoc network mode. Any Tells the MSS to set itself for the channel used by the strongest AP with the same ESSID. Recommended for infrastructure network mode.
Defaults	Any
Examples	Local>> CHANGE 80211 CHANNEL 6 Local>> CHANGE 80211 RESET
See Also	Show 80211, page 2-63

2.2.4 Change 80211 ESSID

```
CHANGE 80211 ESSID { name
                     NONE }
```

Configures the ESSID, which tells the MSS the name of the Extended Service Set (ESS) to which it belongs. Setting an ESSID ensures that the MSS will stay on the desired network subsegment.

Any configuration changes you make will not take place until you issue the **Change 80211 Reset** command.

Restrictions	Requires privileged user status. Only applies to the MSS-VIA and certain MSS4 models.
---------------------	--

Errors	If you enter a command that is not applicable to the 802.11 card currently in use, you will receive an Error message.
Parameters	<p>name Enter a string of up to 32 characters. If the string contains lowercase letters or non-alphanumerics, it may need to be enclosed in double-quotes to be processed properly.</p> <p>None If no ESSID string is set, the MSS will communicate with whichever Access Point (AP) gives the strongest signal, regardless of ESS association. Setting the ESSID to none allows the MSS to associate with any AP within range.</p>
Defaults	ESSID=None
See Also	Show 80211, page 2-63

2.2.5 Change 80211 Fragmentation

```
CHANGE 80211 FRAGMENTATION num
```

Changes the fragmentation threshold.

Any configuration changes you make will not take place until you issue the **Change 80211 Reset** command.

Restrictions	Requires privileged user status.
	Only applies to the MSS-VIA and certain MSS4 models.
Errors	If you enter a command that is not applicable to the 802.11 card currently in use, you will receive an Error message.
Parameters	<p>num Enter an integer between 256 and 2346 to change the fragmentation threshold.</p>
Defaults	2346
See Also	Show 80211, page 2-63

2.2.6 Change 80211 MAC Address

```
CHANGE 80211 MACADDRESS { CARD }
                          { MSS }
```

Configures which of the two available MAC addresses the MSS will use on the network—its own or that of the attached 802.11 wireless networking PC card. The MSS MAC address, which is the same as its hardware address, is printed on bottom label of the MSS.

Any configuration changes you make will not take place until you issue the **Change 80211 Reset** command.

Restrictions	Requires privileged user status. Only applies to the MSS-VIA and certain MSS4 models.
Errors	If you enter a command that is not applicable to the 802.11 card currently in use, you will receive an Error message.
Parameters	Card Instructs the MSS to use the MAC address of the wireless PC card that is inserted into one of its PC card slots. MSS Instructs the MSS to use its own internal MAC address.
Defaults	MSS
Examples	Local>> CHANGE 80211 MACADDRESS CARD Local>> CHANGE 80211 RESET
See Also	Show 80211, page 2-63

2.2.7 Change 80211 Network Mode

CHANGE 80211 NETWORKMODE { <table style="display: inline-table; vertical-align: middle;"> <tr> <td style="text-align: center;">ADHOC</td> </tr> <tr> <td style="text-align: center;">INFRASTRUCTURE</td> </tr> </table> }	ADHOC	INFRASTRUCTURE
ADHOC		
INFRASTRUCTURE		

Denotes whether the MSS operates in a peer-to-peer (AdHoc) or managed (Infrastructure) network environment.

Any configuration changes you make will not take place until you issue the **Change 80211 Reset** command.

Restrictions	Requires privileged user status. Only applies to the MSS-VIA and certain MSS4 models.
Errors	If you enter a command that is not applicable to the 802.11 card currently in use, you will receive an Error message.
Parameters	AdHoc Specifies that the MSS is communicating with other wireless devices in a peer-to-peer capacity. Infrastructure Specifies that the MSS is communicating with an Access Point (AP).
Defaults	Infrastructure
Examples	Local>> CHANGE 80211 NETWORKMODE ADHOC Local>> CHANGE 80211 RESET
See Also	Show 80211, page 2-63

2.2.8 Change 80211 Power

CHANGE 80211 POWER { DEFAULT num }

Controls the card's transmit power settings. The numeric power setting specified must exactly match a value supported by the card.

Any configuration changes you make will not take place until you issue the **Change 80211 Reset** command.

Restrictions	Requires privileged user status. Only applies to the MSS-VIA and certain MSS4 models.
Errors	If you enter a command that is not applicable to the 802.11 card currently in use, you will receive an Error message.
Parameters	Default Sets the card to its default transmit power setting. num Enter a specific milliWatt power setting.
Examples	Local>> CHANGE 80211 POWER DEFAULT Local>> CHANGE 80211 RESET
See Also	Show 80211, page 2-63

2.2.9 Change 80211 Region

CHANGE 80211 REGION { FCC IC ETSI SPAIN FRANCE MKK }

Sets the regulatory region under which you will operate the MSS. Users in the United States can leave this at the default setting (FCC). Other users should set it to correspond with their region.

Any configuration changes you make will not take place until you issue the **Change 80211 Reset** command.

Restrictions	Requires privileged user status. Only applies to the MSS-VIA and certain MSS4 models.
Errors	If you enter a region that will not work with your 802.11 card, an error bit will be displayed when you enter the Show 80211 command.

Parameters	Regions IC: Canada ETSI: Europe, most countries (verify with your local regulatory body) SPAIN: Spain FRANCE: France MKK: Japan
Defaults	FCC
Examples	Local>> CHANGE 80211 REGION FRANCE Local>> CHANGE 80211 RESET
See Also	Show 80211, page 2-63

2.2.10 Change 80211 Reset

```
CHANGE 80211 RESET
```

Resets the MSS so any configuration changes will take effect immediately.

Restrictions	Requires privileged user status. Only applies to the MSS-VIA and certain MSS4 models.
Parameters	Reset Resets the MSS to make all 802.11 changes take effect immediately. This command should be entered anytime you make an 802.11 configuration change. It also clears out any previous errors and starts over with the current 802.11 parameters.
See Also	Show 80211, page 2-63

2.2.11 Change 80211 RTS

```
CHANGE 80211 RTS num
```

Changes the RTS threshold value.

Any configuration changes you make will not take place until you issue the **Change 80211 Reset** command.

Restrictions	Requires privileged user status. Only applies to the MSS-VIA and certain MSS4 models.
Errors	If you enter a command that is not applicable to the 802.11 card currently in use, you will receive an Error message.

Parameters	num Enter a value between 0 and 3000.
Defaults	3000
Examples	Local>> CHANGE 80211 RTS 0 Local>> CHANGE 80211 RESET
See Also	Show 80211, page 2-63

2.2.12 Change 80211 WEP

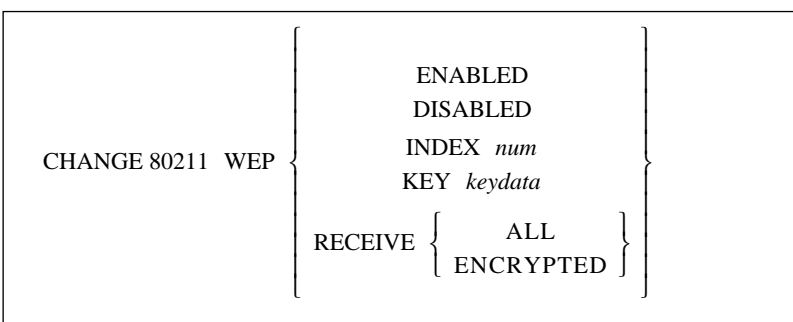

Enabling WEP (Wireless Equivalent Privacy) means the MSS will only connect to an AP (in infrastructure mode) or communicate with other ad-hoc peers (in ad-hoc mode) that have been programmed with the same WEP key as the MSS. All wireless network traffic the MSS sends will be encrypted with its WEP key and any encrypted wireless network traffic the MSS receives will be decrypted with its WEP key. Disabling WEP causes the MSS to ignore its WEP key and only receive and transmit unencrypted network traffic.

Any configuration changes you make will not take place until you issue the **Change 80211 Reset** command.

Restrictions	Requires privileged user status.
	Only applies to the MSS-VIA and certain MSS4 models.
Errors	If you enter a command that is not applicable to the 802.11 card currently in use, you will receive an Error message.
Parameters	<p>Enabled Enables WEP.</p> <p>Disabled Disables WEP.</p> <p>Index Assigns the index number that should be used with the WEP key.</p> <p>num Enter an integer between 1 and 4. For two keys to match, both their key data and their index number must be identical.</p> <p>Key Sets the WEP key. The MSS allows both 40-bit and 128-bit keys, and will determine which key length is being set by the length of the key data.</p>

keydata

Enter the WEP key. The key format should be entered as “xx-xx-xx-xx...” where each x is a hexadecimal digit (0 through 9 and A through F). Each pair of hex digits (xx) defines a byte of key data, and each byte is separated from the next by a dash. For a 40-bit key, 5 bytes of key data must be given. For a 128-bit key, 13 bytes of data must be given.

Receive

Determines whether the MSS will receive unencrypted data while WEP is enabled.

All

Allows reception of encrypted traffic while WEP is enabled. The MSS will accept unencrypted wireless network frames, as well as frames encrypted with its WEP key. This is the default setting once WEP has been enabled.

Encrypted

Refuses to accept unencrypted data while WEP is enabled. The MSS will discard and ignore unencrypted wireless network frames, accepting only frames encrypted with its WEP key.

Defaults Disabled, Receive all

Examples

```
Local>> CHANGE 80211 WEP ENABLED
Local>> CHANGE 80211 WEP INDEX 3
Local>> CHANGE 80211 WEP RECEIVE ENCRYPTED
Local>> CHANGE 80211 RESET
```

See Also Show 80211, page 2-63

2.3 Change Access

CHANGE [PORT <i>PortList</i>] ACCESS <table style="display: inline-table; vertical-align: middle; border: none;"> <tr> <td style="font-size: 3em; vertical-align: middle;">{</td> <td style="padding: 0 10px;">LOCAL DYNAMIC REMOTE NONE</td> <td style="font-size: 3em; vertical-align: middle;">}</td> </tr> </table>	{	LOCAL DYNAMIC REMOTE NONE	}
{	LOCAL DYNAMIC REMOTE NONE	}	

Specifies which types of connections the specified serial port will accept.

Restrictions Requires privileged user status.

The None parameter is only valid for the MSS4.

Autobaud must be disabled for ports set to Dynamic and Remote access.

Errors If a port is active, its access can not be changed.

Parameters **Port**
MSS4 only. Specifies a particular port or group of ports.

Note: *In the absence of the Portlist parameter, the configuration will affect the MSS4's current port only.*

PortList

Specify a particular port or group of ports. Port numbers are specified with integers between 1 and 4, and should be separated with commas (for lists) or dashes (for ranges).

Local

Permits only logins from the attached serial device.

Dynamic

Allows the port to initiate and receive connections.

Remote

Allows the port to accept network connection requests, but does not permit local logins.

None

MSS4 only. Disables both outgoing and incoming connections for the specified port(s).

Defaults

Dynamic

See Also

Change Autobaud, page 2-11.

2.4 Change Autobaud

```
CHANGE [PORT PortList] AUTOBAUD { DISABLED }
                                     { ENABLED }
```

Detects the baud rate used for an incoming connection to the specified port and then changes its own baud rate at login time to match that of the remote device.

When Autobaud is enabled, you may have to press Return several times to help the MSS determine the proper speed.

Restrictions

Requires privileged user status.

Does not apply to the MSS485.

Errors

Autobaud must be disabled for Dynamic and Remote port access.

Autobaud only works when a port is set for 8 bits with No parity or for 7 bits with Even parity.

Autobaud and Autostart are incompatible. If the port is set for Autostart, enabling Autobaud will disable Autostart, clear the Autostart character, and produce an error message.

Parameters**Port**

MSS4 only. Specifies a particular port or group of ports.

Note: *In the absence of the Portlist parameter, the configuration will affect the MSS4's current port only.*

PortList

Specify a particular port or group of ports. Port numbers are specified with integers between 1 and 4, and should be separated with commas (for lists) or dashes (for ranges).

Defaults Disabled

See Also Change Autostart, page 2-12; Change Charsize, page 2-16; Change Parity, page 2-35.

2.5 Change Autostart

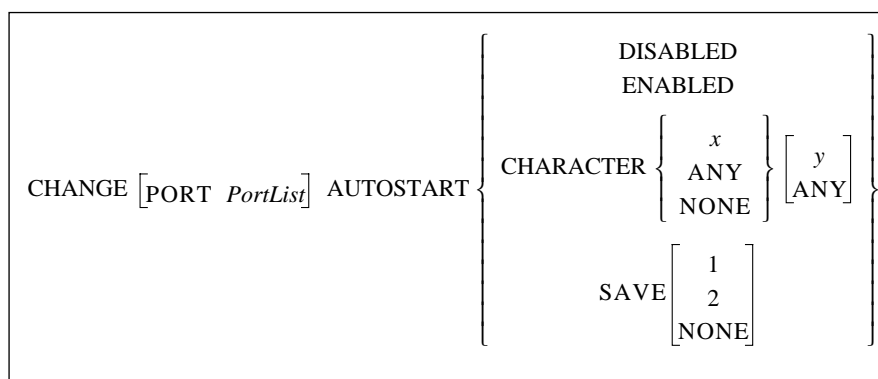

Determines whether the specified port will wait for a carriage return or pre-set character(s) before starting a connection. Enabling Autostart causes the port to start connections automatically. Autostart can also be configured to allow a user-defined sequence of one or two characters to initiate sessions.

If the port is in Dedicated mode, the autostart characters can be sent to the host as the first bytes of data. In all other modes, autostart characters are discarded.

Restrictions Requires privileged user status.

Errors Autostart and Autobaud are incompatible. If the port is set for Autobaud, enabling Autostart will disable Autobaud and produce an error message.

The Save parameter is only applicable when the port is configured with a dedicated host.

If Modem Control is enabled, a port enabled for autostart will not be idle unless DSR is held low, and therefore will not be available for connections from the network.

Parameters **Port**
MSS4 only. Specifies a particular port or group of ports.

Note: *In the absence of the Portlist parameter, the configuration will affect the MSS4's current port only.*

PortList

Specify a particular port or group of ports. Port numbers are specified with integers between 1 and 4, and should be separated with commas (for lists) or dashes (for ranges).

Character

Sets a character that will cause a login event. Users will get the benefit of Autostart without having to hit Return or enable Autostart for extended periods of time.

x

Enter the desired alphanumeric character. To specify a control character, use escaped hex (\xx). For example, Ctrl-B (ASCII character 0x02) would be specified as \02.

y

Enter the optional second alphanumeric character. To specify a control character, use escaped hex (\xx). For example, Ctrl-B (ASCII character 0x02) would be specified as \02.

Any

Sets a wildcard character.

None

Clears the autostart character.

Save

Specifies what happens to the characters that start the connection. Either the first and/or second autostart characters will be passed to the host as the first bytes of data, or the characters will be discarded.

None

Discards the autostart characters.

Defaults

Disabled

Examples

```
Local> CHANGE AUTOSTART ENABLED
Local> CHANGE AUTOSTART CHARACTER A
Local> CHANGE AUTOSTART SAVE 1
```

See Also

Change Access, page 2-10; Change Autobaud, page 2-11; Change Datasend, page 2-17; Change Modem Control, page 2-31; Change Modem Emulation, page 2-32

2.6 Change Backward Switch

```
CHANGE [PORT PortList] BACKWARD SWITCH { character }
                                     NONE }
```

Defines a key that will switch the user to a previous session without entering local mode. From local mode, the key functions as if the **Backward** command was entered. Any key can be specified unless it conflicts with MSS line editing or the Break or Forward keys. The key you specify will be stripped from the data stream, so while it won't interfere with remote operating systems, you will lose any functionality that key would have on local programs.

Restrictions Requires privileged user status.

Parameters **Port**
MSS4 only. Specifies a particular port or group of ports.

Note: *In the absence of the Portlist parameter, the configuration will affect the MSS4's current port only.*

PortList
Specify a particular port or group of ports. Port numbers are specified with integers between 1 and 4, and should be separated with commas (for lists) or dashes (for ranges).

character
Specifies a character to serve as the switch key. To specify a control character, use escaped hex (\xx). For example, Ctrl-B (ASCII character 0x02) would be specified as \02.

None
Clears any previously-defined Backward Switch key.

Defaults No switch

See Also Backward, page 2-2; Change Break, page 2-15; Change Forward Switch, page 2-24; Change Local Switch, page 2-30; Forward, page 2-58.

2.7 Change Bootgateway

```
CHANGE [SERVER] BOOTGATEWAY IPaddress
```

Specifies the IP address of a server to send packets to when downloading code. Setting a bootgateway allows the MSS to download via a router without the router needing proxy arp support.

Note: *A bootgateway host is **not** the loadhost—the packets will be addressed to the loadhost, but will be physically sent to the bootgateway host.*

Restrictions	Requires privileged user status.
Parameters	Server MSS4 only.

2.8 Change BOOTP

```
CHANGE [SERVER] BOOTP { DISABLED }
                       { ENABLED }
```

Disables or enables querying for a BOOTP host at system boot time.

Restrictions	Requires privileged user status.
Parameters	Server MSS4 only.
Defaults	Enabled

2.9 Change Break

```
CHANGE [PORT PortList] BREAK { LOCAL }
                               { REMOTE }
                               { NONE }
```

Determines how and where the Break key will be processed.

Restrictions	Requires privileged user status.
Parameters	Port MSS4 only. Specifies a particular port or group of ports.

Note: *In the absence of the Portlist parameter, the configuration will affect the MSS4's current port only.*

PortList

Specify a particular port or group of ports. Port numbers are specified with integers between 1 and 4, and should be separated with commas (for lists) or dashes (for ranges).

Local

The MSS processes the Break key and returns the user to local mode.

Remote

The MSS ignores the Break key and passes it to the remote host. Only applicable if the session protocol supports Break events. Telnet supports Break events, but Rlogin, raw TCP, and UDP do not.

None

Disables the Break key.

Defaults None

See Also Change Local Switch, page 2-30.

2.10 Change Buffering

```
CHANGE [SERVER] BUFFERING bufferize
```

Specifies the size of the buffer (in bytes) to use for network connections. The default size should be sufficient in most cases.

Restrictions Requires privileged user status.

Parameters **Server**
MSS4 only.

bufferize
Specify a size from 128 to 4096 (bytes).

Defaults 4096 bytes

2.11 Change Charsize

```
CHANGE [PORT PortList] CHARSIZE { 7 }  
{ 8 }
```

Sets the number of data bits per character for the specified serial port.

Restrictions Requires privileged user status.

Errors Autobaud will only work when a port is set for 8 data bits with No parity or for 7 data bits with Even parity.

The MSS100 can only use charsize 8 when parity is set to None. The MSS4 and MSS-VIA can have any parity with charsize 8.

Parameters **Port**
MSS4 only. Specifies a particular port or group of ports.

Note: *In the absence of the Portlist parameter, the configuration will affect the MSS4's current port only.*

PortList

Specify a particular port or group of ports. Port numbers are specified with integers between 1 and 4, and should be separated with commas (for lists) or dashes (for ranges).

Defaults 8 data bits

See Also Change Autobaud, page 2-11; Change Parity, page 2-35.

2.12 Change Datasend

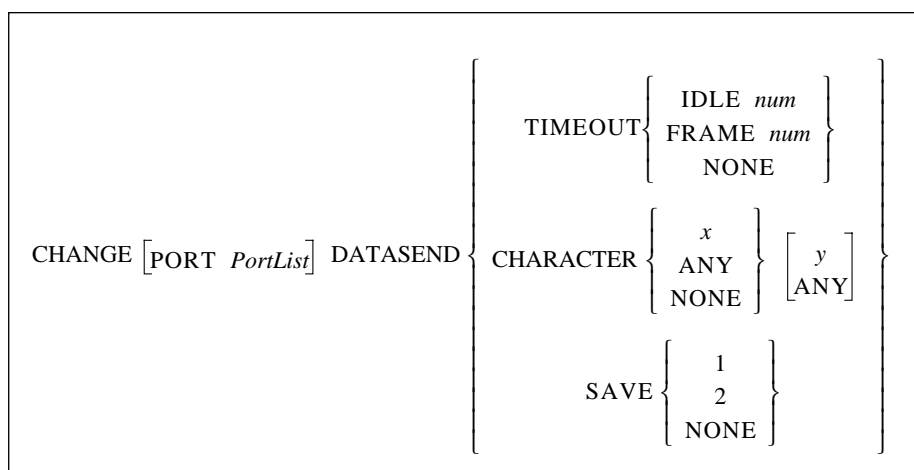

Changes the amount of time the MSS will allow serial characters to accumulate before sending them to the host. Several different triggers can be used to notify the MSS when to send the accumulated data. You can specify a “timeout” condition of either the time since the last character was received (the Timeout Idle parameter) or the time since the current “character burst” was started (the Timeout Frame parameters). The timer resolution on the MSS is approximately 20 milliseconds. Any timeout values lower than 30 milliseconds will be approximated as well as possible.

Another option is to set a one- or two-character trigger, specified through the Character parameter, that will cause the MSS to transmit the data. You can also specify whether the trigger characters will be sent to the host as part of the serial data or whether they should be discarded through the Save parameter.

Packets created by the serial handling rules will be queued to the ethernet driver as a single operation, but there is no guarantee that they will be received at the host in a single network read. If the serial input buffer is filled, the accumulated data will be queued to the ethernet driver regardless of the serial handling rules. The serial input buffer size is 1024 bytes.

Restrictions Requires privileged user status.

Parameters **Port**
MSS4 only. Specifies a particular port or group of ports.

Note: *In the absence of the PortList parameter, the configuration will affect the MSS4’s current port only.*

PortList

Specify a particular port or group of ports. Port numbers are specified with integers between 1 and 4, and should be separated with commas (for lists) or dashes (for ranges).

Timeout

Sets the trigger that allows serial data to be accumulated until a “timeout” condition has been detected.

Idle

Defines the timeout as a period of time since the last character was received.

num

Sets the timeout in milliseconds.

Frame

Defines the timeout as the time since the current “character burst” was started.

None

Clears previous timeout settings, so the transmission takes place whenever the MSS decides to send the data.

Character

Sets a trigger that transmits any accumulated data as soon as the specified one or two byte character sequence is detected in the data stream.

x

Enter the desired alphanumeric character. To specify a control character, use escaped hex (\xx). For example, Ctrl-B (ASCII character 0x02) would be specified as \02.

Any

Sets any character as the trigger.

None

Clears any previous trigger characters.

y

Enter the optional second alphanumeric character. To specify a control character, use escaped hex (\xx). For example, Ctrl-B (ASCII character 0x02) would be specified as \02.

Save

Specifies what happens to the matched trigger characters. Either the first character or both characters will be passed to the host as the first bytes of data, or the characters will be discarded.

Defaults

30 (msec)

Examples

```
Local> CHANGE DATASEND TIMEOUT IDLE 50  
(Triggers data transmission for 50 milliseconds since the last character was received.)
```

```
Local> CHANGE DATASEND TIMEOUT FRAME 150  
(Triggers data transmission for 150 milliseconds since the current “character burst”  
was started.)
```

```
Local> CHANGE DATASEND CHARACTER Z  
Local> CHANGE DATASEND SAVE 1  
(Transmits any accumulated data, including “Z,” as soon as the “Z” character is  
detected in the data stream.)
```

See Also

Change Autostart, page 2-12

2.13 Change Dedicated

CHANGE [PORT <i>PortList</i>] DEDICATED	HOSTLIST
	LAT [<i>servicename:envString</i>]
	NONE
	RLOGIN <i>hostname</i>
	SEQLIST
	SPX <i>SAPname</i>
	TCP <i>hostname:envString</i>

Dedicates a port to a Telnet, Rlogin, or SPX host, or to a LAT service. Once logged into the port, a user is automatically connected to the host or service; the user cannot return to local mode or enter MSS commands. Upon exiting the remote host, the user is logged out of the MSS.

The Hostlist parameter dedicates the specified port to a list of hosts. A sequential hostlist goes through a hostlist and attempts to contact each host in its listed order. As soon as a valid connection is established, normal data flow will occur between the MSS and the connected host. See *Hostlist* on page 2-58 for more information on hostlists.

Note: *Dedicating a port disables port verification. See **Change Verify** on page 2-51 for more details.*

Restrictions Requires privileged user status.

The MSS-VIA, MSS-Lite, and the MSS4 do not support SPX or LAT.

There can only be one dedicated service per port configured at a time. A dedicated service will override a preferred service.

Changes to the dedicated target do not take effect until the port is logged out or the MSS is rebooted.

Errors For all single port MSS, defining the single port as a dedicated port leaves no easy way to log into the MSS. Only remote console port and EZWebCon connections will work.

Specifying the “S” environment string without a timeout value will generate an error. Including an IP address with the “S” string will also generate an error message.

Parameters **Port**
MSS4 only. Specifies a particular port or group of ports.

Note: *In the absence of the *PortList* parameter, the configuration will affect the MSS4’s current port only.*

PortList
Specify a particular port or group of ports. Port numbers are specified with integers between 1 and 4, and should be separated with commas (for lists) or dashes (for ranges).

Hostlist

Dedicates the port to a list of hosts. For more information, see the **Hostlist** command on page 2-58.

LAT

Dedicates the port to a LAT service.

servicename

Enter the name of the desired LAT service.

None

Disables all previously-configured dedicated hosts.

Rlogin

Dedicates the port to Rlogin connections.

Seqlist

Enables a sequential hostlist. When a sequential hostlist is enabled, the MSS will attempt to connect to the first host in the hostlist. If that connection fails, it will attempt to connect to the second host listed, and if that fails, the third host, continuing through all hostlist entries. As soon as a valid connection is established, normal data flow will occur between the MSS and the connected host.

SPX

Dedicates the port to an SPX host.

SAPname

Enter the target SPX host's SAP name.

TCP

Specifies a TCP/IP host. By default, TCP opens a regular Telnet connection that includes Telnet IAC option negotiation. The **:T** environment string allows you to open a raw TCP socket with no Telnet option negotiation, if desired. The **:R** environment string allows you to make an Rlogin connection. A socket number can also be added to connect to a socket other than the default.

hostname

Enter a text host name or a numeric IP address.

envString

Add the desired environment key(s). See *Appendix B* for a complete list of strings. Options must be separated by colons.

Defaults

Disabled

Examples

```
Local> CHANGE DEDICATED TCP chimaera:2001T
(forms a raw Telnet connection to socket 2001 on host chimaera)
```

```
Local> CHANGE DEDICATED TCP :4096US120
(forms a passive UDP connection with any host where once a packet is received, the
MSS will communicate with only that host until 120 seconds of inactivity have
occurred and will then return to the initial state of accepting a UDP packet from any
host.)
```

See Also

Change Preferred, page 2-39; Crypt Password, page 2-52; Hostlist, page 2-58

2.14 Change DHCP

```
CHANGE [SERVER] DHCP { DISABLED }
                       { ENABLED }
```

Enables or disables querying for a DHCP host at system boot time.

Restrictions	Requires privileged user status.
Errors	Configuring an IP address will automatically disable DHCP. Enabling DHCP will remove the IP address saved in non-volatile memory (NVR).
Parameters	Server MSS4 only.
Defaults	Enabled
See Also	The <i>IP Address Configuration</i> section of your <i>Installation Guide</i> .

2.15 Change Domain

```
CHANGE [SERVER] DOMAIN { DomainName }
                       { NONE }
```

Specifies the default domain name to be used when attempting to resolve text TCP/IP host names.

Restrictions	Requires privileged user status.
Parameters	Server MSS4 only. DomainName Enter a domain name of no more than 64 characters. None Disables the previously configured domain name.
See Also	Change Nameserver, page 2-33

2.16 Change DSRLLogout

```
CHANGE [PORT PortList] DSRLLOGOUT { DISABLED }
                                     { ENABLED }
```

If DSRLLogout is enabled, the specified port will be logged out when its DSR signal is de-asserted. This logout usually happens only when the attached device is turned off or disconnected. The feature can be used to keep users from switching physical terminal lines to access other sessions. Open connections will be closed before logout.

Restrictions	Requires privileged user status. Does not apply to the MSS485.
Errors	Modem Control must be disabled to use DSRLLogout. Modem Control implies DSRLLogout.
Parameters	Port MSS4 only. Specifies a particular port or group of ports.
Note:	<i>In the absence of the PortList parameter, the configuration will affect the MSS4's current port only.</i>
	PortList Specify a particular port or group of ports. Port numbers are specified with integers between 1 and 4, and should be separated with commas (for lists) or dashes (for ranges).
Defaults	Disabled
See Also	Change Modem Control, page 2-31.

2.17 Change DTRWait

```
CHANGE [PORT PortList] DTRWAIT { DISABLED }
                                    { ENABLED }
```

If enabled, the MSS will not assert the DTR signal on the specified serial port until a user logs into the port, or until a network connection is made to the port.

Restrictions	Requires privileged user status. Does not apply to the MSS485.
Parameters	Port MSS4 only. Specifies a particular port or group of ports.
Note:	<i>In the absence of the PortList parameter, the configuration will affect the MSS4's current port only.</i>

PortList

Specify a particular port or group of ports. Port numbers are specified with integers between 1 and 4, and should be separated with commas (for lists) or dashes (for ranges).

Defaults

Disabled

2.18 Change Flow Control

CHANGE [PORT <i>PortList</i>] FLOW CONTROL { CTSRTS NONE XONXOFF }

Sets the type of flow control to be used on the specified port.

Restrictions

Requires privileged user status.

Does not apply to the MSS485.

Errors

CTSRTS Flow Control is not available in RS-485 mode.

Parameters**Port**

MSS4 only. Specifies a particular port or group of ports.

Note:

In the absence of the PortList parameter, the configuration will affect the MSS4's current port only.

PortList

Specify a particular port or group of ports. Port numbers are specified with integers between 1 and 4, and should be separated with commas (for lists) or dashes (for ranges).

CTSRTS

Uses RTS/CTS, or hardware, flow control.

None

Flow control is not used.

XONXOFF

Uses XONXOFF, or software, flow control.

Defaults

XONXOFF

2.19 Change Forward Switch

```
CHANGE [PORT PortList] FORWARD SWITCH { character
                                         NONE }
```

Defines a key that will switch the user to the next session without entering local mode. In local mode, the key functions as if the **Forward** command was entered. Any key can be specified unless it conflicts with MSS line editing or the Break or Forward keys. The key you specify will be stripped from the data stream, so while it won't interfere with remote operating systems, you will lose any functionality that key would have on local programs.

Restrictions Requires privileged user status.

Parameters **Port**
MSS4 only. Specifies a particular port or group of ports.

Note: *In the absence of the PortList parameter, the configuration will affect the MSS4's current port only.*

PortList
Specify a particular port or group of ports. Port numbers are specified with integers between 1 and 4, and should be separated with commas (for lists) or dashes (for ranges).

character
Type a character to serve as the switch key. To specify a control character, use escaped hex (\xx). For example, Ctrl-B (ASCII character 0x02) would be specified as \02.

None
Clears the previously-defined Forward Switch key.

Defaults No switch

See Also Change Backward Switch, page 2-14; Change Break, page 2-15; Change Local Switch, page 2-30; Forward, page 2-58.

2.20 Change Gateway

```
CHANGE [SERVER] [SECONDARY] GATEWAY IPaddress
```

Specifies the host that is to be used as a TCP/IP gateway between networks. If a connection to a machine on a different network is attempted, messages will be directed to the gateway for forwarding. The MSS will try to learn gateways automatically if none have been configured.

Restrictions Requires privileged user status.

Errors If a gateway is not defined, an error will be returned.

Parameters

Server
MSS4 only.

Secondary

Configures a gateway to be used when the primary gateway is unavailable.

IPaddress

Specify a host using the numeric IP address format. Specifying an IP address of 0.0.0.0 removes the previously-defined gateway.

See Also

Change Subnet Mask, page 2-47.

2.21 Change Inactive Logout

```
CHANGE [PORT PortList] INACTIVE LOGOUT { DISABLED }
                                         { ENABLED }
```

Determines whether a port will be automatically logged out after a period of inactivity. Any open connections will be closed before logout. Inactivity is defined as having no keyboard or network activity on the port. The inactivity period is set with the **Change Inactive Timer** command.

Restrictions

Requires privileged user status.

Parameters

Port
MSS4 only. Specifies a particular port or group of ports.

Note: *In the absence of the PortList parameter, the configuration will affect the MSS4's current port only.*

PortList

Specify a particular port or group of ports. Port numbers are specified with integers between 1 and 4, and should be separated with commas (for lists) or dashes (for ranges).

Defaults

Disabled

See Also

Change Inactive Timer, page 2-25.

2.22 Change Inactive Timer

```
CHANGE [SERVER] INACTIVE TIMER period
```

Sets the period of time after which a port with Inactive Logout enabled will be considered inactive and automatically logged out.

Restrictions

Requires privileged user status.

Parameters	<p>Server MSS4 only.</p> <p>period Enter a length of time in minutes (1 to 120) or seconds (5 to 60). For minutes, add an m after the number. For seconds, add an s after the number.</p>
Defaults	30 minutes
Examples	Local> CHANGE INACTIVE TIMER 10m
See Also	Change Inactive Logout, page 2-25.

2.23 Change Incoming

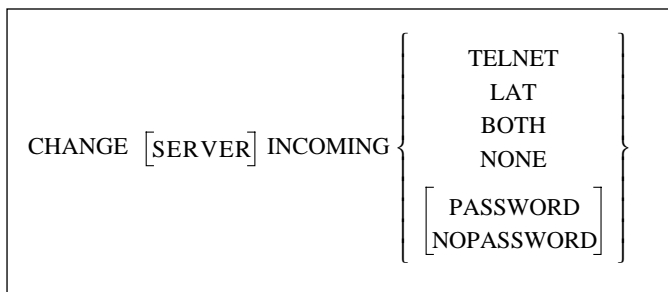

Permits or denies incoming Telnet, Rlogin, and LAT connections and enforces password protection. The Show Server command shows the status of incoming connection parameters.

Restrictions	<p>Requires privileged user status.</p> <p>The MSSLite, MSS-VIA, and the MSS4 do not support LAT or the Both parameter.</p>
Parameters	<p>Server MSS4 only.</p> <p>Telnet Enables incoming Telnet connections.</p> <p>LAT Enables incoming LAT connections.</p> <p>Both Enables incoming Telnet and incoming LAT connections. Only valid on models with LAT support.</p> <p>None Disables all incoming connections.</p>

Password

Prompts the user to enter the login password when attempting an incoming connection.

Nopassword

Allows incoming connections without prompting for the login password.

Defaults Telnet, Nopassword

See Also Change Loginpass, page 2-31.

2.24 Change IPAddress

```
CHANGE [SERVER] IPADDRESS IPaddress
```

Sets the MSS's IP address. The IP address must be set before any TCP/IP functionality is available. The new IP address will take effect immediately.

Restrictions Requires privileged user status.

Errors You will receive an error if the MSS cannot use the specified IP address or if there are currently any network connections.

Parameters

Server
MSS4 only.

IPaddress
Specify the IP address in standard numeric format.

See Also Change DHCP, page 2-21; the *Getting Started* chapter of your *Installation Guide*.

2.25 Change IPSecurity

```
CHANGE IPSECURITY IPaddress {
  [ BOTH
  INCOMING
  OUTGOING ] { ENABLED
  DISABLED }
  PORTS portlist }
```

Adds entries to or edits entries in the IP Security table. The Ports parameter, applicable only to the MSS4, restricts connections to the given IP address from certain ports, and connections from this address to the specified ports.

Restrictions	Requires privileged user status. The Both, Incoming, and Outgoing parameters are only applicable to the MSS4.
Parameters	<p>IPAddress Specify an address in standard numeric format. An address with 0 or 255 in any segment restricts all addresses in that range.</p> <p>Both MSS4 only. Restricts logins from the network into the server and TCP sessions to the network from the server.</p> <p>Incoming MSS4 only. Restricts logins from the network into the server, and connections to the serial port.</p> <p>Outgoing MSS4 only. Restricts TCP sessions to the network from the server.</p> <p>Ports MSS4 only. Specifies a particular port or group of ports.</p> <p>PortList Specify a particular port or group of ports. Port numbers are specified with integers between 1 and 4, and should be separated with commas (for lists) or dashes (for ranges). If a portlist is not specified, all physical and virtual ports apply.</p>
Defaults	Disabled
Examples	<pre>Change IPsecurity 192.0.220.77 Disabled</pre> <p>(Restricts the single IP address from the table.)</p> <pre>Change IPsecurity 192.0.1.255 Both Disabled</pre> <p>(MSS4 only: Restricts all addresses between 192.0.1.0 and 192.0.1.255 from both incoming and outgoing connections.)</p>

2.26 Change LAT CircTimer

CHANGE LAT CIRCTIMER *timerValue*

Specifies the delay between messages sent from the MSS to other network nodes. This parameter should not need to be altered, and should not be altered when there are active sessions.

Restrictions	Requires privileged user status.
Errors	The MSSLite, MSS4, and the MSS-VIA do not support LAT.
Parameters	<p>timerValue Specify a value from 30 to 200 milliseconds.</p>
Defaults	80 (milliseconds)

2.27 Change LAT Groups

```
CHANGE LAT GROUPS { ALL
                   groupList
                   NONE }
```

Specifies the LAT service groups to which the MSS can connect. Groups are numbered from 0 to 255.

Restrictions	Requires privileged user status.
Errors	The MSSLite, MSS4, and the MSS-VIA do not support LAT.
Parameters	groupList Specify a list of groups to replace the current list. Use commas to separate group numbers, and use hyphens to separate ranges.
Defaults	0 (group zero)
Examples	CHANGE LAT GROUPS 17,21-28,118-211,220

2.28 Change LAT Identification

```
CHANGE LAT IDENTIFICATION identString
```

Sets the text string that identifies the MSS on LAT networks.

Restrictions	Requires privileged user status.
Errors	The MSSLite, MSS4, and the MSS-VIA do not support LAT.
Parameters	identString Enter a string of 40 or fewer characters. Enclose the string in quotes if it contains lower-case letters, spaces, or punctuation.

2.29 Change Loadhost

```
CHANGE [SERVER] [SECONDARY] LOADHOST IPaddress
```

Specifies the TCP/IP host from which the MSS requests its runtime code.

Restrictions	Requires privileged user status.
Parameters	Server MSS4 only.

Secondary

Configures a loadhost to be used when the primary loadhost is unavailable.

IPAddress

Specify a host using standard numeric format—host names cannot be resolved via a nameserver. Specifying an IP address of 0.0.0.0 removes the previously-defined loadhost.

2.30 Change Local Switch

```
CHANGE [PORT PortList] LOCAL SWITCH { character }
                                     NONE }
```

Defines a key that will allow you to access local mode from within a session. The Local Switch key functions the same as the Break key. Any key can be specified unless it conflicts with MSS line editing or the Break or Forward keys. The key you specify will be stripped from the data stream, so while it won't interfere with remote operating systems, you will lose any functionality that key would have on local programs.

Restrictions Requires privileged user status.

Parameters **Port**
MSS4 only. Specifies a particular port or group of ports.

Note: *In the absence of the PortList parameter, the configuration will affect the MSS4's current port only.*

PortList

Specify a particular port or group of ports. Port numbers are specified with integers between 1 and 4, and should be separated with commas (for lists) or dashes (for ranges).

character

Specify a character to serve as the switch key. To specify a control character, use escaped hex (\xx). For example, Ctrl-B (ASCII character 0x02) would be specified as \02.

None

Disables the Local Switch key.

Defaults No switch

See Also Change Backward Switch, page 2-14; Change Break, page 2-15; Change Forward Switch, page 2-24.

2.31 Change Loginpass

```
CHANGE [SERVER] LOGINPASS [passwd]
```

Specifies the password used to log into the MSS. The password should consist of no more than 6 alphabetic letters. Users are only required to provide this password if the port has Password Protect enabled.

If you do not enter the password at the command line, you will immediately be prompted to enter the new password. This password is not displayed when typed.

Restrictions	Requires privileged user status.
Parameters	<p>Server MSS4 only.</p> <p>passwd Enter a password of up to 6 alphabetic characters. When entered as part of the command, the password should be enclosed by quotation marks to preserve case.</p>
Defaults	access
Examples	CHANGE LOGINPASS "badger"
See Also	Change Password Protect, page 2-38; Change Incoming, page 2-26.

2.32 Change Modem Control

```
CHANGE [PORT PortList] MODEM CONTROL { DISABLED }
                                         { ENABLED }
```

Causes the MSS to treat any attached serial device as a modem. When enabled, a DSR drop will log out the enabled port and the MSS will drop DTR for three seconds and then raise it when the port logs out. If Autostart is also enabled, the port will not start until DSR is raised. The MSS supports partial modem control (DSR/DTR).

Restrictions	Requires privileged user status.
	Does not apply to the MSS485.
Errors	Modem Control must be disabled to use DSRLLogout.
Parameters	<p>Port MSS4 only. Specifies a particular port or group of ports.</p>
Note:	<i>In the absence of the PortList parameter, the configuration will affect the MSS4's current port only.</i>

PortList

Specify a particular port or group of ports. Port numbers are specified with integers between 1 and 4, and should be separated with commas (for lists) or dashes (for ranges).

Defaults Disabled

See Also Change Autostart, page 2-12; Change DSRLLogout, page 2-22.

2.33 Change Modem Emulation

```
CHANGE [PORT PortList] MODEM EMULATION { DISABLED }
                                         { ENABLED }
```

Presents a modem interface to an attached serial device. The MSS can then accept AT-style modem commands and handle the modem signals correctly. See your *Installation Guide* for more details on modem emulation.

Note: *If the MSS is in modem emulation mode and a serial port is idle, the MSS can still accept network TCP connections to that serial port.*

Restrictions Requires privileged user status.

Does not apply to the MSS485.

Parameters**Port**

MSS4 only. Specifies a particular port or group of ports.

Note: *In the absence of the PortList parameter, the configuration will affect the MSS4's current port only.*

PortList

Specify a particular port or group of ports. Port numbers are specified with integers between 1 and 4, and should be separated with commas (for lists) or dashes (for ranges).

Defaults Disabled

See Also Change Autostart, page 2-12; the *Using the MSS* chapter of your *Installation Guide*

2.34 Change Name

```
CHANGE [SERVER] NAME serverName
```

Renames the MSS. The unit's default name, which is based on its default Ethernet address, is printed on its underside. This name is what will be advertised if WINS is enabled.

Restrictions Requires privileged user status.

Errors	The server name must be unique to the network.
Parameters	<p>Server MSS4 only.</p> <p>serverName Enter a string of up to 16 characters. Strings must be enclosed in quotes if they contain lower-case letters, spaces, or punctuation.</p>
See Also	Change WINS, page 2-51.

2.35 Change Nameserver

```
CHANGE [SERVER] [SECONDARY] NAMESERVER IPaddress
```

Specifies the nameserver to be used during TCP/IP connections. The nameserver will attempt to resolve text host names into numeric IP address form.

Restrictions	Requires privileged user status.
Parameters	<p>Server MSS4 only.</p> <p>Secondary Specifies a nameserver to be used when the primary nameserver is unavailable.</p> <p>IPaddress Specify a host using standard numeric format. Do not enter a text host name.</p>

2.36 Change NetWare Encapsulation

```
CHANGE NETWARE ENCAPSULATION {
    ETHER_II
    NATIVE
    SNAP
    802_2
} {
    DISABLED
    ENABLED
}
```

Configures the frame types that the MSS will pay attention to during IPX connections. When NetWare routing is enabled with the **Change NetWare Routing** command, all frame types are enabled regardless of the settings made with this command.

Restrictions	<p>Requires privileged user status.</p> <p>The MSSLite, MSS4, and the MSS-VIA do not support Netware.</p>
Errors	When enabling more than one frame type, you must enable NetWare Routing.

Parameters	Ether_II Enables Ethernet v2 frame type.
	Native Enables the “native mode” NetWare frame type.
	Snap Enables the 802.2 frame type with SNAP SAPs.
	802_2 Enables the 802.2 frame type with NetWare SAPs.
Defaults	all Enabled (Internal routing also enabled)
See Also	Change NetWare Internal Network, page 2-34; Change NetWare Routing, page 2-35; Show NetWare, page 2-64.

2.37 Change NetWare Internal Network

CHANGE NETWORK INTERNAL NETWORK *number*

Changes the MSS’s preset internal network number, which is derived from the unit’s Ethernet address. This number is used for internal NetWare routing.

Restrictions	Requires privileged user status. The MSSLite, MSS4, and the MSS-VIA do not support Netware.
Parameters	number Specify the new internal network number in the format annnnnnnn where a represents a letter and each n represents a number.
See Also	Change NetWare Encapsulation, page 2-33; Change NetWare Routing, page 2-35; Show NetWare, page 2-64.

2.38 Change NetWare Loadhost

CHANGE NETWORK LOADHOST fileserver
NONE

Specifies the name of the fileserver from which download attempts will be made at boot time.

Restrictions	Requires privileged user status. The MSSLite, MSS4, and the MSS-VIA do not support Netware.
---------------------	--

Parameters	fileserver Enter the name of the desired fileserver using no more than 8 characters.
	None Specifies that no loadhost will be used.
See Also	Change Software, page 2-45.

2.39 Change NetWare Routing

```
CHANGE NETWORK ROUTING { DISABLED }
                       { ENABLED }
```

Allows the MSS to act as an internal router whenever there are multiple NetWare frame types in use on the LAN.

Restrictions	Requires privileged user status. The MSSLite, MSS4, and the MSS-VIA do not support Netware.
Defaults	Enabled
See Also	Change NetWare Encapsulation, page 2-33; Change NetWare Internal Network, page 2-34; Show NetWare, page 2-64.

2.40 Change Parity

```
CHANGE [PORT PortList] PARITY { EVEN }
                                { MARK }
                                { NONE }
                                { ODD }
                                { SPACE }
```

Sets the parity for the specified serial port.

Restrictions	Requires privileged user status.
Errors	Parity must be None for the MSS100 and MSS-VIA to use 8-bit characters. Autobaud will not work unless the port is using 8 bit characters with No parity or 7 bit characters with Even parity.

Parameters	Port MSS4 only. Specifies a particular port or group of ports.
Note:	<i>In the absence of the PortList parameter, the configuration will affect the MSS4's current port only.</i>
	PortList Specify a particular port or group of ports. Port numbers are specified with integers between 1 and 4, and should be separated with commas (for lists) or dashes (for ranges).
Defaults	None
See Also	Change Autobaud, page 2-11; Change Charsize, page 2-16.

2.41 Change Passflow

```
CHANGE [PORT PortList] PASSFLOW { DISABLED }
                                     { ENABLED }
```

Specifies whether XON/XOFF characters will be stripped from the data stream. Enabled means that the MSS will both respond to XON/XOFF and send them to the host. Disabled means that we respond to XON/XOFF but do not send them to the host. Passflow is only useful when XonXoff flow control is set.

Parameters	Port MSS4 only. Specifies a particular port or group of ports.
Note:	<i>In the absence of the PortList parameter, the configuration will affect the MSS4's current port only.</i>
	PortList Specify a particular port or group of ports. Port numbers are specified with integers between 1 and 4, and should be separated with commas (for lists) or dashes (for ranges).
See Also	Change Flow Control, page 2-23.

2.42 Change Password Incoming

```
CHANGE [PORT PortList] PASSWORD INCOMING { DISABLED }
                                           { ENABLED }
```

Controls whether the MSS will ask users for an incoming password when they attempt to connect to the network socket connection ports (ports 200x and 300x, where x is the number of the desired serial port). See *Environment Strings* on page B-1 for more information on network socket connections.

Restrictions Requires privileged user status

Parameters **Port**
MSS4 only. Specifies a particular port or group of ports.

Note: *In the absence of the PortList parameter, the configuration will affect the MSS4's current port only.*

PortList
Specify a particular port or group of ports. Port numbers are specified with integers between 1 and 4, and should be separated with commas (for lists) or dashes (for ranges).

2.43 Change Password Limit

```
CHANGE [SERVER] PASSWORD LIMIT number
```

Limits the number of failures allowed when entering the privileged password, with the **Set Privileged** command, to become the privileged user. After the specified number of retries, the port will be logged out. The **Change Privpass** command is used to set the privileged password.

Restrictions Requires privileged user status.

Parameters **Server**
MSS4 only.

number
Enter a value between 0 (no limit) and 100.

Defaults 3

2.44 Change Password Protect

```
CHANGE [PORT PortList] PASSWORD PROTECT { DISABLED }
                                         { ENABLED }
```

Controls whether a password is needed to log into the MSS from a serial port. For models with a dedicated console port (the MSS-Via, MSS485, and the MSSLite A and C), this command will also affect the serial console port. To set the login password, use the **Change Loginpass** command.

Restrictions Requires privileged user status.

Parameters **Port**
MSS4 only. Specifies a particular port or group of ports.

Note: *In the absence of the PortList parameter, the configuration will affect the MSS4's current port only.*

PortList
Specify a particular port or group of ports. Port numbers are specified with integers between 1 and 4, and should be separated with commas (for lists) or dashes (for ranges).

Defaults Disabled

See Also Change Loginpass, page 2-31.

2.45 Change Portname

```
CHANGE [PORT PortList] PORTNAME name
```

Renames the specified serial port.

Restrictions Requires privileged user status.

Parameters **Port**
MSS4 only. Specifies a particular port or group of ports.

Note: *In the absence of the PortList parameter, the configuration will affect the MSS4's current port only.*

PortList
Specify a particular port or group of ports. Port numbers are specified with integers between 1 and 4, and should be separated with commas (for lists) or dashes (for ranges).

name
Enter a 16-character name composed of alphanumeric characters or the underscore character. Enclose the name in quotation marks to preserve case.

Defaults Port_1 (also Port_2, Port_3, and Port_4 for MSS4 only)

2.46 Change Preferred

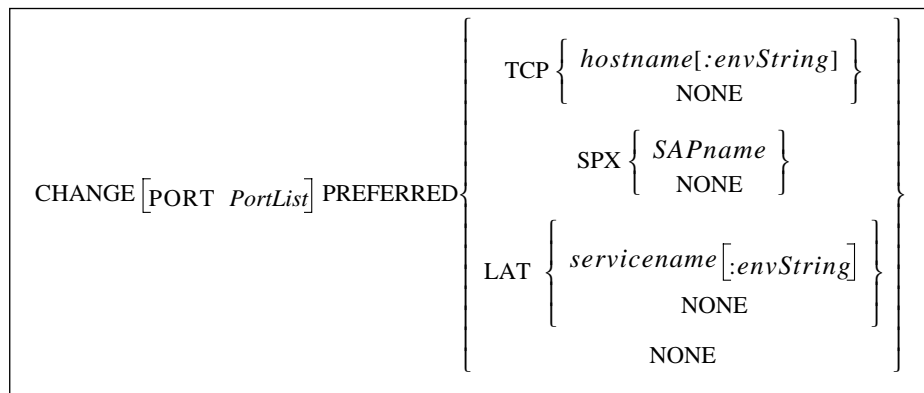

Specifies a default service for the specified port. The MSS will attempt to use the preferred service for autoconnecting, or when no host name is specified for a TCP (Telnet), Rlogin, SPX, or LAT connection command.

Restrictions Requires privileged user status.

The MSSLite, MSS4, and the MSS-VIA do not support LAT or SPX.

Errors A dedicated service will override all preferred services.

Only one preferred service can be configured at a time.

Parameters **Port**
MSS4 only. Specifies a particular port or group of ports.

Note: *In the absence of the PortList parameter, the configuration will affect the MSS4's current port only.*

PortList
Specify a particular port or group of ports. Port numbers are specified with integers between 1 and 4, and should be separated with commas (for lists) or dashes (for ranges).

TCP
Specifies a TCP/IP host. By default, TCP opens a regular Telnet connection that includes Telnet IAC option negotiation. Other connection types can be made using environment strings—see *Change Dedicated* on page 2-19 for more information.

hostname
Enter a text host name or a numeric IP address.

SPX
Specifies an SPX host for the preferred connection.

SAPname
Enter the SPX host's SAP name.

LAT
Specifies a LAT host for the preferred connection.

servicename

Enter the name of the desired LAT service.

envString

Add the desired environment key(s). See *Appendix B* for a complete list of strings. Options must be separated by colons.

None

Clears preferred service configurations.

See Also

Change Dedicated, page 2-19.

2.47 Change Privpass

```
CHANGE [SERVER] PRIVPASS [passwd]
```

Sets the password to become the privileged user. The password should consist of no more than 6 alphabetic letters.

If you do not enter the password at the command line, you will immediately be prompted to enter the new password. This password is not displayed when typed.

Restrictions

Requires privileged user status.

Parameters**Server**

MSS4 only.

passwd

Enter a password of up to 6 alphabetic characters. When entered as part of the command, the password should be enclosed in quotation marks.

Defaults

system

Examples

```
CHANGE PRIVPASS "walrus"
```

See Also

Set Privileged, page 2-63.

2.48 Change RARP

```
CHANGE [SERVER] RARP { DISABLED }
                       { ENABLED }
```

Controls whether the MSS will query for a RARP host at system boot time.

Restrictions

Requires privileged user status.

Parameters**Server**

MSS4 only.

Defaults Enabled

2.49 Change Retransmit Limit

```
CHANGE [SERVER] RETRANSMIT LIMIT number
```

Specifies the number of retries attempted if a network message receives no acknowledgment. This number may need to be increased on noisy or heavily-used networks. The rate at which retransmits are sent is protocol and network dependent.

Restrictions Requires privileged user status.
Applies to TCP and LAT sessions only.

Parameters **Server**
MSS4 only.
number
Enter a value between 4 and 100.

Defaults 10

2.50 Change Rlogin

```
CHANGE [SERVER] RLOGIN { DISABLED }  
                        { ENABLED }
```

Controls the use of the Rlogin command. Incoming Rlogin connections are always permitted, but when Rlogin is disabled, users may not log into remote hosts. To view the current status of Rlogin connections, enter the **Show Server** command.

Restrictions Requires privileged user status.

Parameters **Server**
MSS4 only.

Defaults Disabled

2.51 Change RS485

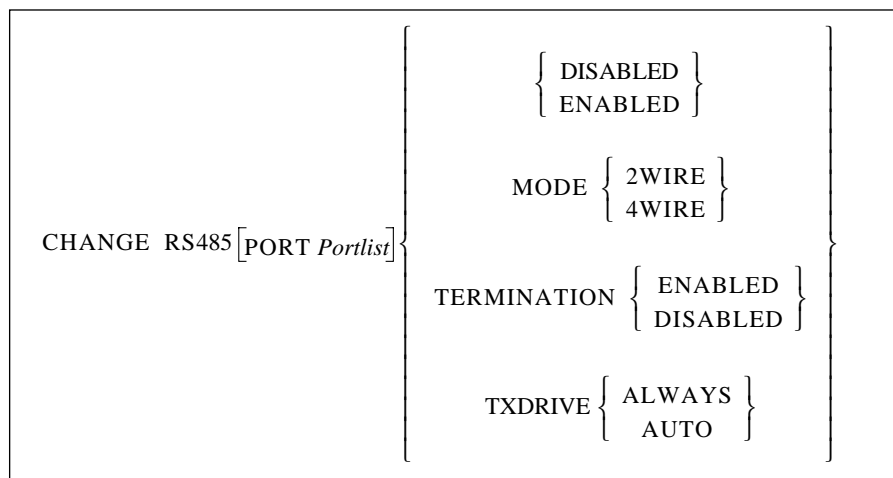

Enables RS-485 networking and configures the necessary RS-485 parameters on the MSS-VIA and the MSS4. RS-485 networking is explained in the *Configuration* chapter of your MSS installation guide.

Restrictions Requires privileged user status.

Errors Only applies to the MSS-VIA and the MSS4 (the MSS485 is configured via jumpers).

Parameters **Port**
MSS4 only. Specifies a particular port or group of ports.

Note: *In the absence of the PortList parameter, the configuration will affect the MSS4's current port only.*

PortList

Specify a particular port or group of ports. Port numbers are specified with integers between 1 and 4, and should be separated with commas (for lists) or dashes (for ranges).

Enabled/Disabled

Enables or Disables RS-485 mode. By default, the MSS is configured for RS-232 networking.

Mode

When RS-485 Mode is enabled, you must choose either two-wire or four-wire mode. If you do not explicitly set a mode with this command, the MSS will default to four-wire mode.

2Wire

Sets the MSS to use two-wire mode.

4Wire

Sets the MSS to use four-wire mode.

Termination

Enable termination whenever you are using long cable runs and Disable it at other times. Only end nodes should be terminated.

TXDrive

Controls how the MSS drives the TX pin.

Always

Sets the MSS to drive TX. The MSS will never tristate TX, even if data is not being sent.

Auto

Sets the MSS to drive TX only when transmitting, and tristate when not transmitting.

Defaults

Disabled
Mode = 4Wire
Termination disabled
TXDrive = Always

2.52 Change Secondary

Users can configure a secondary gateway, loadhost, and/or nameserver in case the primaries are unreachable. For information, please see the **Change Gateway** (page 2-24), **Change Loadhost** (page 2-29), and **Change Nameserver** (page 2-33) command entries.

2.53 Change Session Limit

```
CHANGE [SERVER] SESSION LIMIT number
```

Sets a server-wide limit for active sessions per port.

Restrictions Requires privileged user status.

Parameters **Server**
MSS4 only.

number
Enter a value between 0 and 8.

Defaults 4

2.54 Change Signal Check

```
CHANGE [PORT PortList] SIGNAL CHECK { DISABLED }  
{ ENABLED }
```

Determines whether the MSS will check for the DSR signal when connections are made from the network to a serial port. If the DSR signal is not present, the connection will be rejected.

Restrictions	Requires privileged user status. Does not apply to the MSS485.
Parameters	Port MSS4 only. Specifies a particular port or group of ports.
Note:	<i>In the absence of the PortList parameter, the configuration will affect the MSS4's current port only.</i>
	PortList Specify a particular port or group of ports. Port numbers are specified with integers between 1 and 4, and should be separated with commas (for lists) or dashes (for ranges).
Defaults	Disabled

2.55 Change Silentboot

```
CHANGE [SERVER] SILENTBOOT { DISABLED }
                             { ENABLED }
```

Causes the unit to attempt to boot without sending any status messages to the console port (unless there are errors).

Restrictions	Requires privileged user status.
Parameters	Server MSS4 only.
Defaults	Disabled
See Also	Show Server, page 2-65.

2.56 Change SNMPSetComm

```
CHANGE [SERVER] SNMPSETCOMM communityname
```

Creates an SNMP community name for the MSS and gives that community read/write access. By default, the MSS has a single community (“public”) with read-only access.

Restrictions	Requires privileged user status.
Parameters	Server MSS4 only. communityname Enter an alphanumeric string of up to 15 bytes.

Examples CHANGE SNMPSETCOMM WPHRED
 (adds a single community with read-write access)

See Also The *Configuration* chapter of your *Installation Guide*

2.57 Change Software

```
CHANGE [SERVER] SOFTWARE filename
```

Specifies the name of the download file that, when a reload has been requested, the MSS will attempt to load at boot time.

Restrictions Requires privileged user status.

Parameters **Server**
 MSS4 only.

filename
 Specify a loadfile name of 11 or fewer characters. The server will automatically add a **.SYS** extension to the file name. You can also enter the complete pathname if the file is to be loaded via TFTP; place the filename in quotes to preserve case.

See Also Change Loadhost, page 2-29.

2.58 Change Speed

```
CHANGE [PORT PortList] SPEED rate
```

Specifies the baud rate of the serial port.

Restrictions Requires privileged user status.

Errors An error is displayed if an unsupported baud rate is specified.

Parameters **Port**
 MSS4 only. Specifies a particular port or group of ports.

Note: *In the absence of the PortList parameter, the configuration will affect the MSS4's current port only.*

PortList
 Specify a particular port or group of ports. Port numbers are specified with integers between 1 and 4, and should be separated with commas (for lists) or dashes (for ranges).

rate

Available speeds (baud rates) are generally 300, 600, 1200, 2400, 4800, 9600, 19200, 38400, 57600, 115200, and 230400 baud. The MSSLite can only go as high as 38400 baud.

Defaults

9600 baud

See Also

Change Autobaud, page 2-11.

2.59 Change Startup

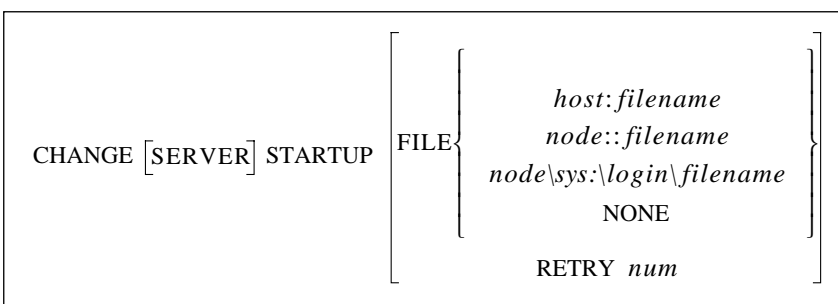

Configures the startup configuration file that the MSS will attempt to download at boot time. The included commands will configure the MSS before any users and services are started. If a text hostname is used for TFTP, the name must be resolvable at boot time, otherwise you must use an IP address.

The Telnet console is available at the time the MSS attempts to download the startup file. If there is a problem with the download, you can still log into the MSS and determine what went wrong.

Restrictions

Requires privileged user status.

The MSSLite, MSS4, and the MSS-VIA do not support LAT or SPX.

Parameters**Server**

MSS4 only.

host:filename

Used to load from a TCP/IP host via TFTP. Enter a TCP/IP hostname or IP address followed by a colon and a startup file name of up to 47 characters. If you use a text host name, it must be resolvable at boot time.

node::filename

Used to load from a VAX machine via LAT. Enter the nodename followed by two colons and the startup file name of up to 47 characters.

node\SYS:\LOGIN\filename

Used to load from a Novell fileserver. Enter the proper node and filename. The entire path should be no more than 47 characters long.

None

Clears any previously configured startup settings.

Retry

Re-attempts load of the startupfile a certain number of times before giving up.

num

Specify the desired number or retry attempts. Enter zero to make the MSS retry until the startupfile is read (indefinitely).

Defaults Retry: 5

Examples

```
Local> CHANGE STARTUP FILE "bob:start"
Local> CHANGE STARTUP FILE hevax::start.com
Local> CHANGE STARTUP FILE "engfs\sys:\login\start.cmd"
Local> CHANGE SERVER STARTUP RETRY 6
```

See Also Change Loadhost, page 2-29; Source, page 2-67.

2.60 Change Stopbits

CHANGE [PORT <i>PortList</i>] STOPBITS $\left\{ \begin{array}{l} 1 \\ 2 \end{array} \right\}$
--

Specifies how many stop bits the port will use.

Restrictions Requires privileged user status.

Parameters **Port**
MSS4 only. Specifies a particular port or group of ports.

Note: *In the absence of the PortList parameter, the configuration will affect the MSS4's current port only.*

PortList

Specify a particular port or group of ports. Port numbers are specified with integers between 1 and 4, and should be separated with commas (for lists) or dashes (for ranges).

Defaults 1

See Also Change Autobaud, page 2-11; Change Charsize, page 2-16; Change Parity, page 2-35.

2.61 Change Subnet Mask

CHANGE [SERVER] SUBNET MASK <i>mask</i>

Sets an IP subnet mask for the MSS. The mask is applied to target IP addresses to determine whether the destination address is on the local network segment. If the address is not on the local segment, the MSS's gateway host will be accessed to provide the connection. A mask is created by default when the IP address is first set, but can be overridden with this command.

Restrictions	Requires privileged user status.
Parameters	<p>Server MSS4 only.</p> <p>mask Specify a mask in numeric IP format, for example, 255.255.255.0.</p>
See Also	Change IPAddress, page 2-27; Change Gateway, page 2-24.

2.62 Change TCPKeepalive

```
CHANGE [SERVER] TCPKEEPALIVE { DISABLED }
                               { ENABLED }
```

Controls the transmission of TCP/IP keepalive packets.

Restrictions	Requires privileged user status.
Parameters	<p>Server MSS4 only.</p>
Defaults	Enabled

2.63 Change Telnetdest

```
CHANGE [SERVER] TELNETDEST { CONSOLE }
                             { SERIAL }
```

Controls what happens when users Telnet into the MSS using the default Telnet socket (23). By default, a Telnet session will get a Local> prompt from the MSS. By specifying the Serial option, a Telnet session will connect directly to the MSS's serial port (port 1 on the MSS4).

Restrictions	Requires privileged user status.
Parameters	<p>Server MSS4 only.</p> <p>Console Users are connected in Local> mode.</p> <p>Serial Users are connected to the serial port as if they Telnetted to port 2001.</p>
Defaults	Console

2.64 Change Telnetpad

```
CHANGE [PORT PortList] TELNETPAD { DISABLED }
                                     { ENABLED }
```

When enabled, Telnetpad tells the MSS to pad carriage returns with null characters during Telnet sessions. The Telnet RFC (Request for Comments) specifies Telnetpad Enabled.

Restrictions Requires privileged user status.

Parameters **Port**
MSS4 only. Specifies a particular port or group of ports.

Note: *In the absence of the PortList parameter, the configuration will affect the MSS4's current port only.*

PortList
Specify a particular port or group of ports. Port numbers are specified with integers between 1 and 4, and should be separated with commas (for lists) or dashes (for ranges).

Defaults Enabled

2.65 Change Termtyp

```
CHANGE [PORT PortList] TERMTYPE { termstring }
                                     NONE }
```

Specifies a terminal type for the desired port. If supported by the network protocol, the MSS reports this string to the remote host.

Parameters **Port**
MSS4 only. Specifies a particular port or group of ports.

Note: *In the absence of the PortList parameter, the configuration will affect the MSS4's current port only.*

PortList
Specify a particular port or group of ports. Port numbers are specified with integers between 1 and 4, and should be separated with commas (for lists) or dashes (for ranges).

termstring
Enter a string of up to 8 characters. The string is converted to all uppercase unless it is enclosed in quotes in the command.

None
Clears the terminal type field.

Examples

```
CHANGE TERMTYPE VT100
CHANGE TERMTYPE IBM1000
```

2.66 Change Timeserver

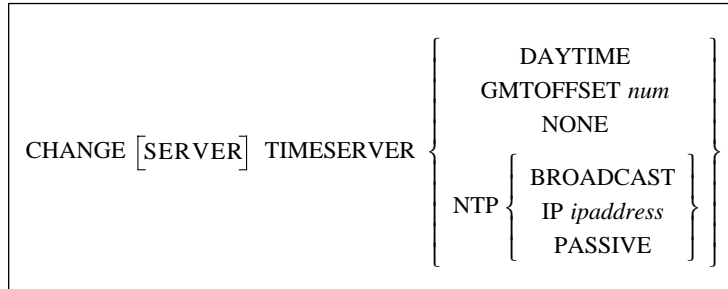

Specifies which timeserver the MSS will use to update its internal clock. The MSS can communicate with either Daytime or Network Timeserver Protocol (NTP) servers. For NTP, the MSS can periodically broadcast a message asking for time information and wait for an NTP timeserver to reply, periodically query a specific NTP timeserver, or just listen for NTP broadcasts on the network.

Parameters

Server
MSS4 only.

Daytime
Specifies a daytime server. The MSS will listen for a possible daytime server, then send packets querying that server for time information.

Note: *Daytime is only supported over UDP.*

GMTOffset
Specifies the local timezone's difference from Greenwich Mean Time (GMT).

num
Enter a value from -12 to +13. For example, the GMTOffset for Los Angeles, CA, USA would be -8 (PST) or -7 (PDT).

None
Clears a previous timeserver setting, but does not clear the GMTOffset setting.

NTP
Specifies an NTP server. There are three types of NTP.

Broadcast
The MSS periodically broadcasts a message that asks for time information, and waits for an NTP timeserver to reply.

IP
Use this method if you have a single NTP timeserver on your network. You must enter an IP address in standard numeric format.

Passive
The MSS will listen for NTP timeserver announcements on the network.

Examples

```
CHANGE TIMESERVER NTP IP 192.0.1.122
CHANGE TIMESERVER GMTOFFFFSET -7
```

2.67 Change Verify

```
CHANGE [PORT PortList] VERIFY { DISABLED }
                               { ENABLED }
```

Controls whether the MSS will provide informational messages whenever a session is connected, disconnected, or switched.

Restrictions Requires privileged user status.

If a port is Dedicated, Verify is disabled.

Parameters **Port**
MSS4 only. Specifies a particular port or group of ports.

Note: *In the absence of the PortList parameter, the configuration will affect the MSS4's current port only.*

PortList
Specify a particular port or group of ports. Port numbers are specified with integers between 1 and 4, and should be separated with commas (for lists) or dashes (for ranges).

Defaults Enabled

2.68 Change WINS

```
CHANGE [SERVER] WINS { DISABLED }
                      { ENABLED }
```

Allows the MSS to broadcast a WINS name announcement at boot time, and answer broadcast WINS name queries. This setting allows other hosts to locate the MSS.

Restrictions Requires privileged user status.

Parameters **Server**
MSS4 only.

Defaults Disabled

2.69 Crypt Password

CRYPT PASSWORD *password*

Changes the password used for the encryption mode environment string (:Y). Both ends of the connection must agree on the encryption password being used. You must reboot after changing the encryption password.

Note: *To use the encryption features for your MSS, you must use a special software file. Contact Lantronix for more information.*

This command can be used to configure an MSS to MSS encrypted session. Set the encryption password on both units to be the same password, reboot both units, then telnet either to one of the unit's local prompts (i.e. socket 2100) or serial port (i.e. socket 210x where x is the serial port number) using the :Y environment string. Sockets 2100 and 210x are assumed to be encrypted on the receiving MSS.

Restrictions Requires privileged user status.

Parameters **password**
Enter a new encryption password. The password can be up to 7 alphanumeric or escaped hex (\xx) characters and is case sensitive.

See Also Change Dedicated, page 2-19; Hostlist, page 2-58.

2.70 Disk

DISK {	CAT <i>file</i>	}
	CD <i>directory</i>	
	CHMOD <i>code file</i>	
	CP <i>file1 file2</i>	
	DF <i>/disk</i>	
	/FLASH	
	FORMAT <i>/PCCARD1</i>	
	/PCCARD2	
	FSCK	
	HEAD <i>file</i>	
	LN <i>flag file1 file2</i>	
	LS [<i>flag</i>] <i>file</i>	
	MKDIR <i>directory</i>	
	MORE <i>file</i>	
	MV <i>file target</i>	
	OD [<i>flag</i>] <i>file</i>	
	PWD	
	RM [<i>flag</i>] <i>file</i>	
	RMDIR <i>directory</i>	
	SYNC	
TAIL <i>file</i>		
TEST [<i>flag</i>] <i>file</i>		
TOUCH <i>file</i>		

Performs disk management functions for the MSS and, for models with PC card support, for any installed ATA flash card. The MSS contains two modifiable directories—/ram and /flash—and one read-only directory—/rom. For MSS models with one PC card slot, an ATA card can be accessed as /pccard1; for models with two slots, the card in the top slot can be accessed as /pccard1 and the card in the bottom slot as /pccard2.

The Disk commands are very similar to the file management commands in UNIX environments. Unlike the similar UNIX commands, each disk command must be preceded by the word DISK. The commands are also not case-sensitive.

The Disk commands honor disk permissions. All disks are read only for non-privileged users.

Restrictions

The Format and FSCK parameters requires privileged user status.

Only apply to the MSS4, MSS100, MSSLiteX, and the MSS-VIA.

The ROM disk is read-only and cannot be modified by users.

Errors For the /pccard1 and /pccard 2 parameter, you will receive an error if either the specified card is not a storage card or if there is no card in the slot.

Parameters**Cat**

Displays an entire file in your terminal window.

Cd

Changes your current working directory.

Chmod

Changes permissions for a file or directory. To assign permissions, enter a 3-digit number. The first digit represents the owner's permissions. The second digit represents the group's permissions. The third digit represents the world's permissions.

Digit	Meaning
0	No permissions.
1	Execute permission only.
2	Write permission only.
3	Write and Execute permissions.
4	Read permission only.
5	Read and Execute permissions.
6	Read and Write permissions.
7	All permissions.

Cp

Copies or moves a file. To copy a file, enter the filename for file1 and the new file name as file2. To move a file, specify the filename as file1 and the destination directory as file2.

Df

Displays the blocks of free space on the MSS disks. When you add the -i switch, the display includes in the display the number of inodes used versus the number still available.

/disk

Enter the disk name, e.g. /flash.

Format

Formats either the Flash disk or the specified PC card with the Lantronix filesystem.

/Flash

Formats or erases the /flash disk.

/PCCard1 and /PCCard2

Formats an ATA flash card for use in an MSS PC card slot. An unformatted card can not be used by the MSS. The /pccard1 parameter applies to all MSS products with one PC card slot (MSS-VIA) or the first (top) slot of the MSS4. The /pccard2 parameter applies to the bottom PC card slot of the MSS4.

Fsck

Checks the MSS filesystem and corrects any problems.

Head

Outputs the beginning of a string.

Ln

Creates a hard or soft link for files, linking a file or set of files to another file. using no flag creates a hard link. Adding the -s flag creates a soft link.

Ls

Displays the contents of a directory. The available flags are:

-l	Returns a list in long form, which includes information about modification date, size, owner, and permissions.
-t	Sorts the list by modification date, with the newest file appearing first.
-r	Reverses the order of the file listing. For example, if -t was also specified, -r would list the oldest file first.

Mkdir

Creates a new directory on the MSS RAM or flash disk.

More

Displays the contents of a file on the terminal, 24 lines of text at a time. Normally the display pauses after each screen and prints "--MORE--" at the bottom of the screen. To access the next screen, press the Space bar. To abort, press Ctrl-C.

Mv

Moves files or directories on the MSS RAM and flash disks. You can also rename files with this command by inserting the new filename for *target*

Od

Displays the contents of the specified file as raw hexadecimal byte values. The possible flags are:

-b	Prints the bytes in octal format.
-ct	Prints the bytes in ASCII format.
-x	Prints the bytes in hexadecimal format.

Pwd

Displays the full pathname of your current directory.

Rm

Removes files and/or directories from the MSS RAM and Flash disks. The possible flags are:

-i	Prompts for a Y (yes) or N (no) before the file is removed.
-r	Removes an entire directory and all of its subdirectories.

Rmdir

Removes a directory from the specified disks. The command can only be used if the directory is empty. If the directory is full, you must add the **DISK RM -rf** command.

Sync

Forces the MSS to write files to flash immediately. Normally, when the MSS is rewriting files to the Flash disk, it will buffer data before initiating a write sequence. Write sequences are automatically written after 5 seconds of disk inactivity.

Tail

Outputs the end of a file.

Test

Evaluates a file (true or false). The possible flags that will be returned are:

-d	True if file exists and is a directory.
-e	True if file exists (regardless of type).
-f	True if file exists and is a regular file.
-l	True if file exists and is a symbolic link.
-r	True if file exists and is readable.
-w	True if file exists and is writable. True indicates only that the write flag is on. The file is not writable on a read-only file system even if this test indicates true.
-x	True if file exists and is executable. True indicates only that the execute flag is on. If the file is a directory, true indicates that the file can be searched.

Touch

Creates an empty disk file.

Examples

```
Local>> DISK CHMOD 755 /PCCARD1/index.txt
Local>> DISK FORMAT /PCCARD1
Local>> DISK LS -l /PCCARD1/
Local>> DISK TEST /PCCARD1/add.exe
```

2.71 Delete IPsecruity

```
DELETE IPSECURITY { IPaddress
                    ALL }
```

Removes entries from the IP Security table.

Restrictions	Requires privileged user status.
Errors	An error will be returned if the IPsecruity entry does not exist.
See Also	Change IPsecruity, page 2-27; Show IPsecruity, page 2-64.

2.72 Disconnect

```
DISCONNECT session
```

Terminates the current session or specified session(s).

2.73 Finger

```
FINGER [username] [[@]hostname]
```

Displays information about local and remote users. This command is an implementation of the Unix Finger command. Port information will not be displayed.

Restrictions	An error is returned when the host cannot be accessed.
Parameters	<p>username Enter a username to display information about that particular MSS user.</p> <p>hostname Enter a hostname to display information about all of the users at the specified host site.</p> <p>username@hostname Enter both parameters with the “at” symbol (@) to display information about a particular user on that host.</p>

2.74 Forward

FORWARD

When entered in local mode, moves users one session forward (to a more recent session).

See Also Backward, page 2-2; Change Backward Switch, page 2-14; Change Forward Switch, page 2-24; Change Local Switch, page 2-30.

2.75 Help

HELP [*keyword*]

Allows the user to view command syntax information. Typing **Help** alone will show a list of top-level commands.

Parameters **keyword**
Specify one of the top-level commands to view suboptions of that command.

2.76 Hostlist

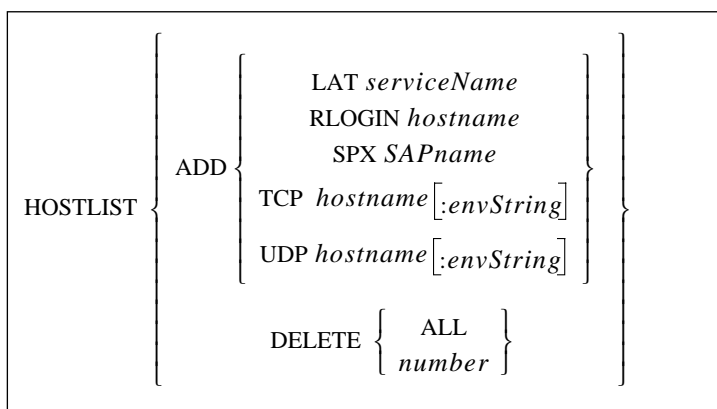

Edits the hostlist used for multihost mode connections. There can be a maximum of 12 hosts in the hostlist. For information on Multihost Mode, which sets up a data pipe between one of the serial devices attached to the MSS and multiple network hosts, see the *Using the MSS* chapter of your *Installation Guide*.

Restrictions Requires privileged user status.

The MSS-VIA and the MSS4 do not support SPX or LAT.

Parameters **LAT**
Adds a LAT service to the host table.

servicename

Enter the name of the desired LAT service.

Rlogin

Adds an Rlogin entry to the host table.

hostname

Enter the IP address of the target host. For UDP only, resolvable hostnames and broadcast/multicast IP addresses can be used.

SPX

Adds an SPX entry to the host table.

SAPname

Enter the SPX host's SAP name.

TCP

Adds a TCP entry to the host table. By default, TCP opens a regular Telnet connection that includes Telnet IAC option negotiation.

UDP

Adds a UDP entry to the host table.

envString

Add the desired environment key(s). See *Appendix B* for a complete list of strings. Options must be separated by colons.

Delete

Removes one or all entries from the hostlist.

number

Specify which entry to remove. To view configured host entries, enter the **Show Hostlist** command.

See Also

Change Dedicated, page 2-19; Crypt Password, page 2-52; Show Hostlist, page 2-64

2.77 Initialize

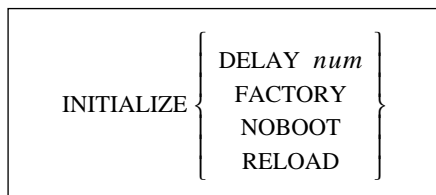

Reboots the MSS.

Restrictions

Requires privileged user status.

Errors

When Reload or Factory initialization takes place, all user-entered commands are lost; the MSS must be reconfigured.

Parameters**Delay**

Schedules a reboot after a specified number of minutes.

num

Enter the number of minutes, from 0 (immediate) to 120.

Factory

Reboots the MSS with its factory-configured settings.

Noboot

Cycles power on the MSS, but without booting. The MSS will remain in the Boot Configuration Program (BCP). See your installation guide for more details on BCP.

Reload

Downloads operational software upon reboot.

See Also

Appendix C, *Updating Software*.

2.78 LAT

```
LAT serviceName [envString]
```

Establishes a connection with a LAT service. If you do not specify a service or hostname, the MSS will attempt a connection to the preferred host or service.

Errors

Does not apply to MSSLite, MSS-VIA, or the MSS4.

Parameters**serviceName**

Enter the name of the desired LAT service, for example, “modem”.

envString

Add the desired environment key(s). See *Appendix B* for a complete list of strings. Options must be separated by colons.

Examples

```
Local> LAT modem:LD=port5
```

2.79 Logout Port

```
LOGOUT [PORT] [PortList]
```

Logs out the serial port, disconnecting any existing sessions. For the MSS4, you can log out multiple serial ports at once. Can also be used to log out modem card ports (Port 3 on the Via, Ports 5 and 6 for the MSS4).

Parameters**Port**

Logs out the current port if entered by itself or, if used with the PortList parameter, logs out the specified port.

Note: *In the absence of the PortList parameter, the configuration will affect the MSS4's current port only.*

PortList

MSS4 and MSS-Via only. Specify a port number as an integer between 1 and 3 (Via) or 1 and 6 (MSS4). You can not log out multiple ports at once.

number

Enter a port number.

2.80 Netstat

```
NETSTAT
```

Displays currently-active NetWare and TCP/IP network connections and the depth of UDP packet queues. This information is primarily intended for debugging network problems.

2.81 Ping

```
PING hostname [length]
```

Sends an IP echo packet request to another network host, and provides an easy way to test IP network connections. In general, any host that supports IP will respond if it is able, regardless of login restrictions, job load, or operating system. If the host does not reply, there may be a network IP configuration problem.

Parameters**hostname**

Enter either a resolvable text host name or a numeric IP address.

length

Length of the ping packet. The default length is 50 bytes.

2.82 Resume

```
RESUME [session]
```

Leaves local mode and resumes the current (most recently active) session or the specified session.

Errors

An error is returned if there are no active sessions.

Parameters**session**

Specify the number of the session you wish to resume.

2.83 Rlogin

```
RLOGIN IPaddress [username]
```

Attempts to log in to a remote host as a local user.

Parameters

IPaddress

Specify a resolvable text host name or a numeric IP address. This parameter is optional if a preferred Telnet service has been defined.

username

Specify a name to be used as the login name.

2.84 RTC

```
RTC [SET [DATE date]  
      [TIME time]  
      SHOW]
```

Sets the real time clock (RTC) on the MSSLite-A and MSSLiteX-A.

Restrictions

Only valid on the MSSLite-A and MSSLiteX-A.

Parameters

Set

Sets either the date or time.

Date

Sets the date. Must be used with the *date* parameter.

date

Enter the date as MM/DD/YY.

Time

Sets the time. Must be used with the *time* parameter.

time

Enter the time as HH:MM:SS.

Show

Shows the current RTC date and time settings.

Examples

```
Local_2>> RTC SET DATE 01/19/01  
Local_2>> RTC SET TIME 17:01:16  
Local_2>> RTC SHOW TIME
```

2.85 Set Privileged

```
SET { PRIVILEGED [OVERRIDE]
      NOPRIVILEGED }
```

Changes the port's privileged status.

Note: *If you forget the password, you must reset the MSS to its factory defaults. See **Initialize** on page 2-59 for instructions.*

Restrictions Secure users may not become the privileged user.

Only one port at a time can be the privileged port.

Parameters

Privileged

Allows a user to become the port's privileged user, provided the user enters the correct password.

Override

Forces the current port to become the privileged port (the previous port loses the privilege).

Noprivileged

Removes privileged status for the port.

See Also Change Privpass, page 2-40.

2.86 Show 80211

```
SHOW 80211 [ANTENNA]
            [POWER]
```

Displays the current wireless networking settings. Entering the command without any parameters displays basic 80211 settings including Region, MAC address, and ESSID. Also displayed are any 802.11 errors, which are discussed in Appendix B, *Show 802.11 Errors*.

Errors Only applies to the MSS-VIA and MSS4.

Parameters

Antenna

Displays the antenna diversity options (RX and TX) available on the currently installed 802.11 card.

Power

Displays, in milliWatts, the transmit power settings supported by the currently installed 802.11 card.

See Also Change 80211, page 2-2; Show 802.11 Errors, page B-1.

2.87 Show Hostlist

```
SHOW HOSTLIST
```

Displays the current list of remote hosts to use for multihost mode connections.

See Also *Status Displays*, page 5-6; *Multihost Mode*, page 5-11; *Hostlist*, page 2-58.

2.88 Show IPsecurity

```
SHOW IPSECURITY
```

Displays the current TCP/IP security table. Each address or range is shown, along with the direction of concern.

See Also *Status Displays*, page 5-6.

2.89 Show NetWare

```
SHOW NETWARE
```

Displays NetWare characteristics, including frame types, routing status, and internal network number.

Errors Does not apply to MSSLite, MSS-VIA, or the MSS4.

See Also *Status Displays*, page 5-6.

2.90 Show Nodes

```
SHOW NODES { LAT }
            { SPX }
```

Displays information about the desired LAT or SPX service nodes.

Errors All nodes will be shown if no node is specified.

Does not apply to the MSS-Via, MSS4, or MSSLite.

Parameters **LAT**
Shows LAT nodes identification strings and availability.

SPX

Shows SPX node hop counts, frame types, and availability.

See Also

Status Displays, page 5-6.

2.91 Show Ports

```
SHOW PORTS [ ALL ]
            [ PortList ]
```

Displays all serial port settings, including the port's connection status, the flow control state, the state of DSR and DTR serial signals, the access type, and more. Can also be used to display modem card information (for the MSS-Via, Port 3; for the MSS4, Ports 5 and 6).

Parameters**All**

MSS4 only. Shows the port settings on all serial ports.

PortList

MSS4 and MSSVia only. Port numbers are specified with integers between 1 and 4. Port numbers should be separated with commas (for lists) or dashes (for ranges).

See Also

Status Displays, page 5-6.

2.92 Show RS485

```
SHOW RS485
```

Displays the current RS-485 networking settings, including wire mode, termination, and TXDrive.

Errors

Only applies to the MSS-VIA and MSS4.

See Also

Change RS485, page 2-42.

2.93 Show Server

```
SHOW SERVER [ BOOTPARAMS ]
            [ COUNTERS ]
            [ CHARACTERISTICS ]
```

Displays different types of MSS information. If you do not enter a parameter, the MSS will display general server characteristics .

Parameters**Bootparams**

Displays MSS parameters that relate to the boot procedure and software loadfile.

Counters

Displays Ethernet and TCP/IP error information.

Characteristics

Displays server settings including hardware address, timer limit, password limit, session limit, retransmit limit, IP address, subnet mask, nameserver, gateway, and more.

Defaults

Characteristics

See Also

Status Displays, page 5-6.

2.94 Show Services

```
SHOW SERVICES [serviceName]
```

Displays the characteristics of the LAT services on the network.

Restrictions

This list is masked by the service groups that the port is able to see. In other words, users will not be able to see services to which they cannot connect.

Errors

Does not apply to MSSLite, MSS-VIA, or the MSS4.

Parameters**serviceName**

Specify a service whose information you want to see. Wildcards are permitted.

All services will be shown if no service is specified.

See Also

Status Displays, page 5-6.

2.95 Show Session

```
SHOW SESSION
```

Displays information about the serial port's current session(s). For the MSS4, this command shows the current session(s) for the current serial port.

See Also

Status Displays, page 5-6.

2.96 Show SNMP

SHOW SNMP

Displays configured SNMP communities and their access modes (read-only or read/write). The default community name is **public**, and allows read-only access. There is one additional user-configurable SNMP community.

See Also *Status Displays*, page 5-6; *Change SNMPSetComm*, page 2-44.

2.97 Show Users

SHOW USERS

Displays the current users logged into the MSS, their port usernames, and current connection information.

See Also The *Status Displays* section in your *MSS Installation Guide*.

2.98 Show Version

SHOW VERSION

Displays operating software version information.

Errors Applies to the MSS4 only.

See Also *Change Software*, page 2-45

2.99 Source

SOURCE *hostname:filename*

Downloads a configuration file from a TFTP host. The file is assumed to contain lines of server commands to be executed. The Source command is most useful for trying out a configuration file before using the Change Software command.

Errors Only applies to the MSS-VIA and MSS4.

Parameters **hostname:filename**
Enter the TFTP hostname (either a text name or an IP address) followed by a colon and the download path and file name.

Examples Local> SOURCE "labsun:start.com"

See Also Change Startup File, page 2-46

2.100 SPX

SPX *SAPname*

Attempts a connection to an SPX-enabled device on the network. SPX devices announce their availability to the network with SAP names; the target device must be advertising itself via SAP announcements for the MSS to make a connection.

Errors Does not apply to the MSSLite, MSS-VIA and MSS4.

Parameters **SAPname**
Enter the target device's SAP name, for example, MSS_XXXXXX.

2.101 Telnet

TELNET *IPaddress*[:*envstring*]

Initiates a Telnet connection to a remote host. An environment string can also be specified as described below. If you have previously configured a preferred host, you can enter the command without a parameter to automatically connect to the preferred host.

Errors There can be no space between the hostname and the colon (:), or between the colon and the environment string.

Parameters **IPaddress**
Enter a text host name or an IP address. This parameter is only optional if a preferred service has been defined.

envString
Add the desired environment key(s). See *Appendix B* for a complete list of strings. Options must be separated by colons.

Examples Local> Telnet 192.0.1.201:T
(Forms a raw TCP connection to the specified host)

Local> Telnet phred:7000
(Connects to the remote console port on host phred)

See Also Change Dedicated, page 2-19; *Status Displays*, page 5-6.

2.102 Test

```
TEST [PORT PortList] [DTR [DELAY num]]
```

Tests a serial port's connection. When the Test command is entered without any parameters, test lines of 70 characters are sent to the specified serial port until a key is pressed.

Restrictions Nonprivileged users may only test their current port.

Parameters **Port**
MSS4 only. Specifies a particular port or group of ports.

Note: *In the absence of the PortList parameter, the configuration will affect the MSS4's current port only.*

PortList
Specify a port number as an integer between 1 and 4. You can not specify more than one port at a time.

DTR
Lowers and then raise the DTR signal on the serial port. If a delay is not specified, DTR will lower for approximately one second and then raise.

Delay
Lowers DTR will for the specified delay length, then raises DTR.

num
Enter a delay time from 50 to 3,000 (milliseconds).

2.103 Zero

```
ZERO
```

Resets all counters on the MSS (both serial and Ethernet).

Restrictions Requires privileged user status.

A: Contact Information

If you are experiencing an error that is not listed in *Appendix B* of your *Installation Guide*, or if you are unable to fix the error, contact your dealer or Lantronix Technical Support at 800-422-7044 (US) or 949-453-3990. Technical Support is also available via Internet email at support@lantronix.com.

A.1 Problem Report Procedure

When you report a problem, please provide the following information:

- ◆ Your name, and your company name, address, and phone number
- ◆ Lantronix MSS model number
- ◆ Lantronix MSS serial number
- ◆ Software version (use the **Show Server** command to display)
- ◆ Network configuration, including the information from a **Netstat** command
- ◆ Description of the problem
- ◆ Debug report (stack dump), if applicable
- ◆ Status of the unit when the problem occurred (please try to include information on user and network activity at the time of the problem)

A.2 Full Contact Information

Address:

Phone: 949/453-3990

Fax: 949/453-3995

World Wide Web: <http://www.lantronix.com>

North American Direct Sales: 800/422-7055

North American Reseller Sales: 800/422-7015

North American Sales Fax: 949/450-7232

Internet: sales@lantronix.com

International Sales: 949/450-7227

International Sales Fax: 949/450-7231

Internet: intsales@lantronix.com

Technical Support: 800/422-7044 or 949/453-3990

Technical Support Fax: 949/450-7226

Internet: support@lantronix.com

B: Environment Strings

B.1 Usage

An environment string is a sequence of key letters, sometimes prefixed by a plus (+) or minus (-). Environment strings can be used with **Change Dedicated**, **Change Preferred**, **Hostlist**, **LAT**, and **Telnet** to configure connections. The keys are added after the hostname (if one is given) and a colon.

Key letters are not case-sensitive, and no white space is allowed in the environment string. In addition, commands that oppose previously-configured settings will overwrite the previous setting, even if they appear on the same command line.

Note: *Because of the syntax difference between the commands for the MSS4 and other MSS models, you should read the Command Reference chapter carefully before entering a command. The examples given in the following sections may not apply to your MSS model.*

B.1.1 Multiple Strings

More than one string can be entered as part of a single command. Multiple strings do not need to be separated from each other. For example, you can enter a command that specifies both the desired port number and that the connection should be encrypted.

Figure B-1: Entering Multiple Strings

```
Local>> CHANGE PREFERRED TELNET 192.0.1.3:2001Y
```

B.2 Available Strings

Note: *In most applications, environment strings are not necessary.*

Environment keys must be separated from the hostname, if one is specified, by a colon. Read the following sections carefully for more details on proper usage of each key.

Table B-1: Environment Strings

<i>nnnn</i>	socket number (TCP and UDP only)	
C	+C = CR to CRLF,	-C = CR to LF
D	+D = Backspace mode	-D = Delete mode
E	+E = Local Echo mode	-E = Remote Echo mode
OR	Speaks the redirector protocol over the network connection	
OS	Sends SYN packets less frequently, for slow-bandwidth networks.	
P	+P = Passall mode	-P = Passthru mode

Table B-1: Environment Strings

R	Rlogin protocol (sets port number to 513 if not already set)
T	TCP mode (raw uninterpreted data stream)
U	UDP mode (the default UDP socket is 4096)
S	Specifies session mode. Only valid with U.
xxxx	Timeout value in seconds, up to 3600 (1 hour). Only valid with :S
Y	Encrypted mode (raw TCP socket that encrypts all data using a 56-bit key)
LD=port#	Sets the LAT destination port to port#
LN=node#	Sets the target LAT node to node#

B.2.1 Usage Examples

These examples should illustrate the proper usage of the above environment strings.

2.2.1.1 nnnn

Sets a socket number. For TCP and UDP connections only. The most common socket numbers are 7000 (the MSS remote console port), 200x (for Telnet IAC interpretation), and 300x (for raw TCP/IP), where x is the number of the desired serial port.

Examples

```
% telnet 192.0.1.88:7000
(connects to the remote console port of the specified host)

% telnet 192.0.1.66:3001
(forms a raw TCP/IP connection to the MSS serial console port)

Local> TELNET 192.0.1.45:2003
(forms a connection with Telnet IAC interpretation to the third serial port of an MSS4)
```

See Also Your MSS *Installation Guide* for more information on socket connections

2.2.1.2 +C and -C

+C specifies CR to CRLF. -C specifies CR to LF.

Examples

```
Local>> CHANGE PREFERRED TELNET 192.0.1.3:+C
```

2.2.1.3 +D and -D

+D sets Backspace mode. -D sets Delete mode.

Examples

```
% telnet 192.0.1.5:-D
```

2.2.1.4 +E and -E

+E sets Local Echo mode. -E sets Remote Echo mode.

Examples

```
% telnet 192.0.1.48:+E
```

2.2.1.5 OR

Sets up a dedicated redirector connection. Enabling Autostart for the dedicated port, as shown in the example below, will automatically start the redirector connection.

More information about the Lantronix Com Port Redirector software is available in your *MSS Installation Guide*.

Examples Local>> CHANGE DEDICATED TCP 192.0.2.25:OR
Local>> CHANGE AUTOSTART ENABLED

See Also Change Dedicated, page 2-19; Change Autostart, page 2-12

2.2.1.6 OS

Sends TCP SYN packets less frequently. This string is useful for slow-bandwidth networks

Examples % telnet 192.0.1.78:OS

2.2.1.7 +P and -P

+P specifies Passall method. -P specifies Passthru mode. Both Passall and Passthru will prevent the proper handling of the Forward and Backward keys.

Examples Local>> CHANGE DEDICATED TELNET 192.0.1.221:+P

2.2.1.8 R

Specifies that the connection use the Rlogin protocol. Sets the port number to 513 if not already set.

Examples Local>> CHANGE DEDICATED TCP 192.0.1.8:R

2.2.1.9 T

Forms a raw Telnet connection. If no environment string is specified, a Telnet connection is assumed.

Examples Local> CHANGE DEDICATED TCP chimaera:2001T

2.2.1.10 U

Sets the connection to UDP mode. The default UDP socket is 4096.

To configure a passive UDP session, do not enter a hostname before the environment key(s). If you want the MSS to spoof a connection with whatever host sends a packet, use the S and xxxx keys along with :U. In this state, the MSS will accept a packet from any host, and then wait for either another packet from that host or a timeout of xxx seconds. The timeout sends the MSS back to passive mode.

Parameters S
Only valid with the U environment string.

xxxx
Sets the session timeout value in seconds, up to 3600 (one hour). Only valid with the :S string.

Examples

```
Local>> CHANGE DEDICATED TCP 192.73.220.1:U
```

```
Local>> CHANGE DEDICATED TCP :U
(forms a passive UDP session with any host)
```

```
Local>> CHANGE DEDICATED TCP :US60
(forms a passive UDP session where the MSS will wait 60 seconds after receiving a
packet from one host before returning to passive mode)
```

```
Local> CHANGE DEDICATED TCP :4096US120
(forms a passive UDP connection with any host where once a packet is received, the
MSS will communicate with only that host until 120 seconds of inactivity have
occurred and will then return to the initial state of accepting a UDP packet from any
host.)
```

2.2.1.11 Y

Sets up encrypted mode, a raw TCP socket that encrypts all data using a 56-bit key, for the MSS.

Note: *To use the encryption features for your MSS, you must use a special software file. Contact Lantronix for more information.*

This string can be used in conjunction with the encryption password to establish encrypted sessions between two MSS products. To set up an encrypted session, set the encryption password on both MSS units to the same password and reboot both units. Then, establish an encrypted session from one unit to the other. For example, entering the command given in the example would set up an encrypted session to the second unit's first serial port.

Note: *To change the encryption key used for encryption mode, see Crypt Password on page 2-52.*

Examples

```
Local> TELNET 192.0.2.25:2101Y
(where 2101 is the encrypted serial port on the MSS)
```

```
Local> TELNET 192.0.2.25:2100Y
(will give you an encrypted local prompt on the specified MSS)
```

See Also

Crypt Password, page 2-52

2.2.1.12 LD=port#

Sets the LAT destination port to port#. The MSSLite, MSS-Via and MSS4 do not support LAT.

Examples

```
Local> LAT modem LN=vax8:LD=0005
```

2.2.1.13 LN=node#

Sets the target LAT node to node#. The MSSLite, MSS-Via and MSS4 do not support LAT.

Examples

```
Local> LAT modem LN=vax8:LD=0005
```

B: Show 802.11 Errors

B.1 Introduction

When you enter the **Show 80211** command without any other parameters, the resulting screen includes a field for errors. The “**Errors:**” field displays two eight-digit numbers, separated by a comma. These numbers are a 64-bit wide bitfield of error bits, each one indicating whether or not the given error has occurred at least once.

For example, suppose you're using an MSS-Via with a ZoomAir card in Infrastructure mode. After having been running for a long time, your Access Point loses power in the middle of sending a fragmented packet to the MSS. If you entered the **Show 80211** command, you might see a screen resembling the following:

Figure B-1: Example of Error Bits

```
Local_5>> SHOW 80211
802.11 Support:           Active
Network Type:             Infrastructure
Use MAC address from:     MSS (00-80-a3-30-ee-31)
ESS ID:                   (none set)
Regulatory Region:       FCC/USA
DS Channel:               Any
RTS Threshold:            3000
Fragmentation Threshold: 2346
Card Present:             Zoom Air 4000

Status:                   Scanning
Errors:                   08020002,00000920

Card Firmware Revision:  2.01
```

The Errors bitfield is zeroed each time you issue either a **Zero** command or a **Set 802.11 Reset** command at the Local> prompt.

The Errors bitfield is zeroed each time you issue either a **Zero** command or a **Change 802.11 Reset** command at the Local> prompt.

B.2 Error Bits

B.2.1 Leftmost Number

- | | |
|-----------------|--|
| 80000000 | An authentication or association sequence timed out. An expected reply from the AP was not received within the required time window. |
| 40000000 | Internal error. |
| 20000000 | Internal error. |

10000000	Internal error.
08000000	Fragment reassembly timed out. Failed to receive all the fragments of a fragmented 802.11 packet before the reassembly window expired. Dropped some correctly received fragments.
04000000	Received an 802.11 packet with invalid subtype code.
02000000	Received an 802.11 packet with invalid type code.
01000000	Received an 802.11 packet with invalid version code.
00800000	Dropped a correctly received 802.11 packet due to lack of a sufficiently sized buffer to hold it. May happen under heavy network load if applications are not processing network data fast enough.
00400000	Internal error.
00200000	Internal error.
00100000	Failed to transmit an 802.11 management packet.
00080000	Failed to transmit an 802.11 data packet.
00040000	Internal error.
00020000	Lost contact with the AP. Unit will attempt to reestablish contact by itself.
00010000	Unit was deauthenticated or disassociated by the AP for attempting to pass data packets before being fully associated. (Indicates confusion of either the unit or the AP.)
00008000	Unit was disassociated by the AP for inactivity.
00004000	Unit was deauthenticated or disassociated by the AP because the AP is going offline or being reconfigured to serve a different network.
00002000	Unit was deauthenticated by the AP because its previous authentication is no longer valid.
00001000	Authentication or association with the AP failed, or the unit was deauthenticated or disassociated by the AP for an unknown reason.
00000800	Association with the AP failed because the unit does not support all of the data rates marked as basic in the AP.
00000400	Association with the AP failed, or the unit was disassociated by the AP because the AP is full, and cannot handle any more stations associating with it.
00000200	Authentication with the AP timed out. The AP did not receive an expected reply from the unit within the required time window.

00000100	Authentication with the AP failed because the WEP key the unit is using is not the same as the key the AP is using.
00000080	Authentication with the AP failed because either the unit or the AP sent an incorrect authentication packet. Some APs will erroneously return this error code when the problem is actually "authentication type not allowed".
00000040	Authentication with the AP failed because the AP does not allow the authentication type requested by the unit.
00000020	Authentication or association with the AP failed for administrative reasons.
00000010	Reassociation with another AP serving the same ESS as the previous one failed because the association could not be confirmed by the previous AP.
00000008	Association with the AP failed because the AP does not support all 802.11 options requested by the unit.
00000004	Authentication or association with the AP failed, or the unit was deauthenticated or disassociated by the AP for a reason explicitly given as "unspecified".
00000002	Could not find any beacons matching the network parameters the unit is configured with. Most likely there is no AP or ad-hoc network within range that satisfies the unit's ESSID, NETWORK-TYPE, and CHANNEL parameters.
00000001	Internal error.

B.2.2 Rightmost Number

80000000	Unassigned.
40000000	Unassigned.
20000000	Unassigned.
10000000	Unassigned.
08000000	Unassigned.
04000000	Unassigned.
02000000	Unassigned.
01000000	Unassigned.
00800000	Unassigned.
00400000	Unassigned.
00200000	Unassigned.

00100000	Unassigned.
00080000	Unassigned.
00040000	Unassigned.
00020000	Internal error. May occur on some cards in conjunction with other described error codes.
00010000	The 802.11 card in use is not compatible with the regulatory region to which the unit has been programmed.
00008000	Internal error.
00004000	Internal error. May occur on some cards in conjunction with authentication or association failures, or other configuration mismatches.
00002000	Received an 802.11 packet that was too large to be handled.
00001000	Internal error.
00000800	Failed to queue a data packet that could not be sent immediately for later transmission. It was dropped.
00000400	Internal error.
00000200	Failed to find, sync to, and associate with an AP or ad-hoc network within a reasonable time. Most likely there is no AP or ad-hoc network within range that satisfies the unit's ESSID, NETWORK-TYPE, and CHANNEL parameters.
00000100	Received an 802.11 data packet that was not encapsulated as per RFC1042 or 802.1h. Unit will still decapsulate and interpret the packet. Some vendors' APs trip this error when they send out "magic packets" containing proprietary extensions not defined by the 802.11 spec.
00000080	Received an 802.11 data packet encapsulated in a completely foreign manner, or not encapsulated at all. Unit will still attempt to interpret the packet, but proper interpretation is not guaranteed. The packet may be dropped as unintelligible.
00000040	Received an encrypted packet that could not properly be decrypted. Packet was dropped.
00000020	Unspecified error during packet reception. At least one packet was dropped. Absence of this error bit does not imply that all packets have been received correctly, however.
00000010	A received packet failed CRC check and was dropped.
00000008	Internal error. May occur in conjunction with "no AP or ad-hoc network within range" errors.

00000004	Internal error.
00000002	Internal error.
00000001	Internal error.

Index

Numerics

802.11 **2-2**, **2-63**
 Antenna **2-3**
 Channel **2-4**
 Errors **C-1**
 ESSID **2-4**
 Fragmentation **2-5**
 MAC address **2-5**
 Network mode **2-6**
 Power **2-7**, **2-8**
 Region **2-7**
 RTS **2-8**
 WEP **2-9**

A

Access mode **2-10**
Antenna, 802.11 **2-3**
ATA flash cards **2-53**
Autobaud **2-11**
Autostart **2-12**

B

Backward switch **2-2**, **2-14**
Baud rate **2-45**
Boot Configuration Program (BCP) **2-60**
Bootgateway **2-14**
BOOTP **2-15**
Break key **2-15**
Buffering **2-16**

C

Channel, 802.11 **2-4**
Character size **2-16**, **2-17**
Circuit timer **2-28**
Command line
 Editing **1-2**
Command syntax **1-1**
Community name (SNMP) **2-44**
Contact information **A-1**
Counters **2-69**

D

Datasead **2-17**

Dedicated connections **2-19**
DHCP **2-21**
Disconnect command **2-57**
Disk management **2-53**
Domain name **2-21**
DSR (Data Signal Ready)
 Signal checking **2-43**
DSRLogout **2-22**
DTRWait **2-22**

E

Encrypted mode **2-52**, **B-4**
Encrypted sessions
 MSS to MSS **2-52**, **B-4**
Encryption password **2-52**, **B-4**
Environment strings **B-1-??**
ESSID, 802.11 **2-4**

F

Factory defaults **2-59**
Finger **2-57**
Flash disk **2-53**
Flow control **2-23**
Forward switch **2-24**, **2-58**
Fragmentation, 802.11 **2-5**
Frame types **2-33**

G

Gateway **2-24**

H

Help **1-3**
Help command **2-58**
Hostlist **2-20**, **2-58**
 Displaying **2-64**
 Editing **2-58**
 Sequential **2-20**

I

Inactivity timer **2-25**
Incoming connections **2-26**
 Password **2-26**, **2-37**
Initialize **2-59**

Internal network number **2-34**

IP

Address **2-27**

Security **2-27, 2-57, 2-64**

IPX (NetWare)

SPX **2-68**

L

LAT **2-60, 2-64**

Circuit timer **2-28**

Destination port **B-4**

Groups **2-29**

Identification **2-29**

Target node **B-4**

Loadhost **2-29, 2-34**

Local switch **2-30**

Login password **2-26, 2-31**

Logout **2-60**

Inactivity **2-25**

M

MAC address, 802.11 **2-5**

Modem

Control **2-31**

Emulation **2-32**

Multihost mode **2-64**

N

Nameserver **2-32**

Netmask **2-47**

Netstat **2-61**

NetWare **2-64**

Encapsulation **2-33**

Internal network number **2-34**

Loadhost **2-34**

Routing **2-35**

Network mode **2-6**

Networking, wireless **2-2**

P

Parity **2-35**

Passflow **2-36**

Passive UDP **B-3**

Timeout value **B-3**

Passwords **2-37**

Limit **2-37**

Login **2-31, 2-37**

Privileged **2-40, 2-63**

Protect **2-38**

Ping **2-61**

Ports

Name **2-38**

Privileged **2-63**

Settings **2-65**

Speed **2-45**

Power, 802.11 **2-7, 2-8**

Preferred connections **2-39**

Privileged password **2-40, 2-63**

Problem report procedure **A-1**

R

RARP **2-40**

Rebooting **2-59**

Redirector connections **B-3**

Region, 802.11 **2-7**

Resume **2-61**

Retransmit limit **2-41**

Rlogin **2-20, 2-41, 2-62, B-3**

Routing, NetWare **2-35**

RS-485 **2-42, 2-65**

RTC (Real-time Clock) **2-62**

RTS, 802.11 **2-8**

S

Sequential hostlist **2-20**

Serial delay **2-17**

Server characteristics **2-65**

Server name **2-32**

Services **2-66**

Sessions **2-66**

Limit **2-43**

Set privileged **2-63**

Show commands **2-63, 2-64, 2-65**

Signal checking **2-43**

Silent boot **2-44**

SNMP **2-67**

Community name **2-44**

Sockets **B-2**

Software **2-45, 2-67**

SPX **2-64, 2-68**

Startup file **2-46**

Stop bits **2-47**

Subnet mask **2-47**

Switches

Backward **2-14**

Forward **2-24**

Local **2-30**

T

- Telnet **2-48, 2-68**
 - Padding characters **2-48, 2-49**
 - Raw connections **B-3**
- Terminal type **2-49**
- Test command **2-69**
- Timers
 - Circuit **2-28**
 - Inactivity **2-25**
- Timeserver **2-50**

U

- UDP **2-50, B-3**
 - Passive **B-3**
- Unix commands **2-53**
- Users **2-67**

V

- Verification **2-51**

W

- WEP (Wireless Equivalent Privacy) **2-9**
- WINS **2-51**
- Wireless **2-2, 2-63**

Z

- Zeroing counters **2-69**